

3

ENGLISH

THROUGH PICTURES



I.A. RICHARDS / CHRISTINE M. GIBSON

ENGLISH

THROUGH PICTURES

Book 3

Updated Edition

I. A. RICHARDS
CHRISTINE M. GIBSON

Pippin Publishing
Toronto
2005

Reproduced from volumes held in the Language Research, Inc.
Collection, Monroe C. Gutman Library, Special Collections,
Harvard Graduate School of Education.

Copyright © 1973 by I.A. Richards and Christine Gibson

English Through Pictures, Book 3: Copyright © 1957, by
Language Research, Inc.

The above copyrights have been assigned to the President and
Fellows of Harvard College. This updated version is published by
Pippin Publishing Corporation, which holds Copyright © 2005
in the updated material, and is subject to Copyright © 2004 by
the President and Fellows of Harvard College. All rights reserved.
No part of this publication may be reproduced or transmitted in
any form or by any means, electronic, mechanical or otherwise,
including photocopying and recording, or stored in any retrieval
system without permission in writing from the publisher.

Cover Designed by John Zehethofer

Cover Photo: Burke/Triolo Productions/Brand X Pictures/Getty Images

New maps and graphs drawn by Christopher Johnson.

Printed and bound in Canada by AGMV Marquis Imprimeur Inc.

Library and Archives Canada Cataloguing in Publication

Richards, I. A. (Ivor Armstrong), 1893-1980.

English through pictures : book III / by I.A. Richards,
Christine M. Gibson.—Updated ed.

First published 1945 under title: The pocket book of basic English.

Includes index.

ISBN 0-88751-115-5

1. Basic English. 2. Vocabulary. 3. English language—
Textbooks for second language learners. I. Gibson, Christine M.
II. Richards, I. A. (Ivor Armstrong), 1893-1980 Pocket book of
basic English. III. Title.

PE1128.R533 2005 428.1 C2005-900406-1

NOTES ON THE RE-ISSUE AND UPDATE OF ENGLISH THROUGH PICTURES

DESIGN FOR LEARNING

These three pocketbooks are the remarkable invention of I. A. Richards and Christine Gibson. Designed for learning English in the quickest and clearest way—through pictures—learners are invited right from the beginning to put widely useful words to work in key sentence patterns where meaning is clearly shown in pictures. Each sentence situation builds to a successful discovery of the next, while confirming mastery of the earlier steps. The simplified black and white drawings allow the learner to focus on the sentence patterns and on success in taking control of language. Comparisons of sentence situations can be made on the individual frames on a page and through a systematic building on all that has gone before. Workbooks included in *Books I* and *II* challenge and reinforce growing competencies, while at the same time providing enriched reading and writing well within the learner's grasp. Motivation for learning comes from handling increasingly complex patterns successfully and confidently.

WORDS WITH POWER

The three pocketbooks focus on a small, careful selection of the most widely useful English words put into key patterns. These are words with power to define other words and to improve the possibilities of successful communication in any field of human endeavour. Today these are the words of an English most commonly employed throughout the planet. *Book I* contains a vocabulary of 250 words; an additional 500 word vocabulary is developed in *Book II*. These 750 words are used in *Book III* to build a command of 1000 words which, by their defining power, hold the possibility of understanding another 20,000 words of English. *Book III* invites learners to explore much useful information

about the world in which they live while continuing the crucial process of learning to learn. Words with power become instruments for thinking. The purpose of the pocketbooks is to supply starting points from which learners can go out in different directions as their interests may take them. These are books of beginnings.

TOWARD A WORLD ENGLISH

These materials have been used successfully by millions in more than forty countries. They have been used as a self-teacher by learners of all ages, in schools and in all those diverse settings in the world where a command of English is needed. The materials are the result of extensive research and field testing for over fifty years.

Although many users' first language will be English, millions more will come to English as a second or alternative language. For this group, assistance is needed to move the learner beyond visual comprehension to a command of both spoken and written English. The most effective help will come from a teacher with a command of English who can act as a model and make corrections on pronunciation. Assistance can come as well from audio materials directly matched with the text, with space for the learner to practice speaking.

In updating *English Through Pictures*, the greatest care has been taken at all times to maintain the integrity of the learning system. The updating of this re-issue is to be found mainly in *Book II* and *III*. Dates, prices, population figures, other factual information, and selected illustrations have been updated for current usage. This updating must, of course, be a continuous exercise by the learners. The pocketbooks must become their own, and a base or frame on which future learning can be mounted safely and effectively.

Archie MacKinnon
February, 2005

PREFACE

This is a new book in a series whose *English Through Pictures*, *Books I and II* have been used by millions. *Book III* keeps in mind that its readers will have many different needs. Some will want more English to help them to find work, some as a step on the way to higher education, some for business, travel or better living—and some because English opens for them a window with a wider outlook on the world.

We have tried in designing *English Through Pictures Book III* to serve all these needs. However, our first care has been the ordering of the teaching itself. What comes next must everywhere be supported by what has gone before and must make ready for what is to come. Too much too quickly—without examples or time enough to compare and to work out the relations of part with part—is the chief cause of broken English.

As with *English Through Pictures, Books I and II*, this book can be used in many ways: as a self-teacher, a schoolbook, a blueprint or design for recordings, filmstrips, sound motion pictures and television. It is the purpose of this book to supply starting points from which people can go out in different directions as their different interests take them. We hope it will be a book of beginnings.

Christine M. Gibson
I. A. Richards

Contents

English Through Pictures Book III *1*

Index 235

“I am here.”



Where is “here”?

Where are you? Where do you live?

Who are you? What is your name?

live: the place where you are living or have your house is where you live.

FUTURE
will live

PRESENT
live(s)

PAST
lived

“I am here”



is the first statement in *English Through Pictures, Book I (EP 1)*

That book uses about five hundred words of English in a great number of different ways.

Using those same words, together with about the same number of new words and more pictures, this book (*EP 3*) goes farther into the language.

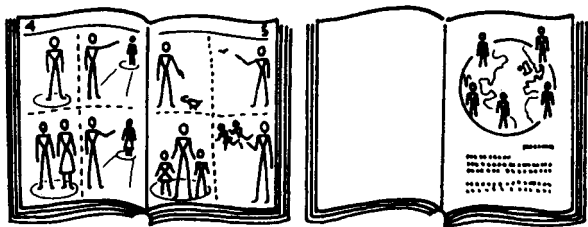

This new book uses about a thousand words of English.

use: when you make use of something you use it.

language: all the words used by persons talking or writing to one another.

will use

use(s)

used

Are you a man or a woman or a girl or a boy? What is your country? Is the country where you live now the country of your birth?

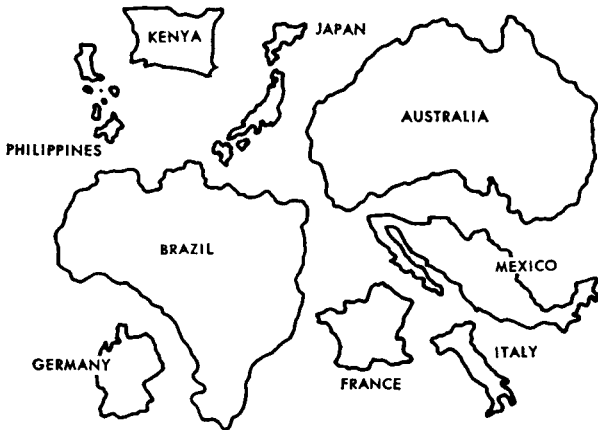

Do you see on this page a map of the country where you live? Is it Germany, the Philippines, Brazil, Australia, Kenya, or some other country?

There are millions of readers of *EP 1*. The book is used in almost every country.

country: land under one government.

birth: coming into being (see pages 4, 5 and 7).

almost: the shorter line here is almost as long as the other.

“almost every country:” most countries.

“What is your name?” the man on the right asks. The other man answers: “My name is Jean Schmidt.”



“Where do you come from? What is the country of your birth? Where were you born?” (These are different ways of asking the same question.)

“Geneva, Switzerland,” answers Jean Schmidt.

“Have you any relations in this country?”

“Yes, I have one. My uncle, my father’s brother, lives in Boston, Massachusetts, U.S.A.”

asks: puts a question.

answers: gives an answer.

born: given birth or given being.

any: one or more, some. In answering the question “Have you any money?” we say “Yes, I have some” (not “Yes, I have any”). If we have no money, we say “No, I haven’t any.”

relation: person of some family.

uncle: father’s or mother’s brother.

will ask

will answer

ask(s)

answer(s)

asked

answered

“When were you born? Give me the date of your birth. What is your age?”

JANUARY						
				1	2	3
4	5	6	7	8	9	10
11	12	13	14	15	16	17
18	19	20	21	22	23	24
25	26	27	28	29	30	31

“I was born on January 10, 1970. I am thirty-five (years old).”

“When were you at school? How long were you there? How many years were you at school?”



“I was at school eight years.”

“What work do you do? What is your occupation?”



“I am a cook.”

date: day of the month and year. If you give the day, month and year of your birth, that is a way of giving your age, saying how old you are.

age: your age is the number of years you have lived.

how many: what number of.

many: a great number of.

occupation: work.

cook: person who makes food ready by heating it and in other ways (see *EP 1*, p. 93).

Here are some people of different countries.

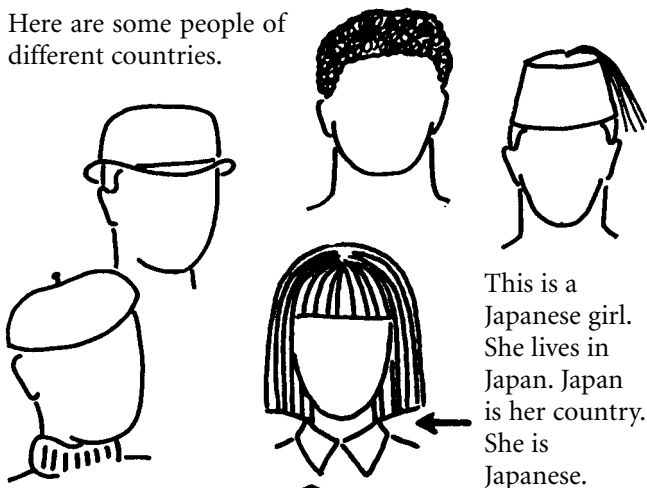

This is an Indian boy. He lives in India. India is his country.

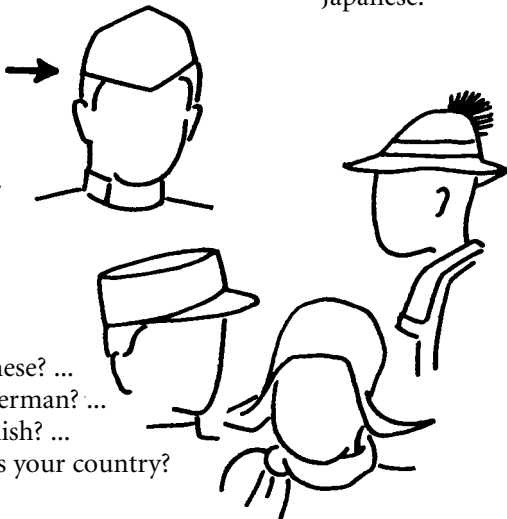

Are you Japanese? ...
Chinese? ... German? ...
French? ... Polish? ...
Swiss? What is your country?

people: men and women and boys and girls are people.

Here are some people who live in the United States of America, the U.S.A. The fathers and mothers of these people went to the U.S.A. from England, France, China, Japan, Italy, Switzerland, Poland, Russia and other countries. Some of them sailed there in sailing ships before the days of steamships.



Now the sons and daughters live in the U.S.A. and most of them are Americans. Some of them were born in the U.S.A. They got their start in America, but they have many relations in the old country.

sail: sailing ships have sails and sail by using the push of the wind.

start: if a person goes for a walk, the start of the walk is the very first step. Being born is the start or starting point of a person, and their age at a given date is the time they have been living from the start (from their birth).



will sail

sail(s)

sailed

Japan and India and China are parts of Asia. Germany, Italy and France are in Europe. In all these countries there are many people. In some countries there is very little land for the size of the population. Europe has less land than Canada and not much more than the U.S.A., but it has a population more than fifteen times as great as Canada's. And the numbers keep going up. Between 1850 and 1950, more than thirty million people went from Europe to live in the U.S.A., but the population of Europe in 1954 was greater than the populations of North and South America together.

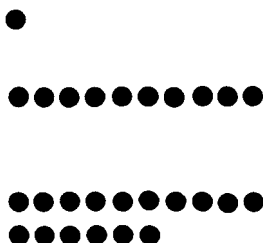

times as great: in this picture B is four times the size of A. It is four times as great as A.

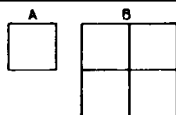

population: the population of a place is the number of people living in it.

There were 25,000,000 more people in Europe in 2004 than there were fifty years before. The increase in population in fifty years was 25,000,000. Europe increased her population by 25,000,000 in the last fifty years.

Today there are over 475,000,000 people in Europe.

This map gives a picture of the number of people in each country of Europe in 2004.

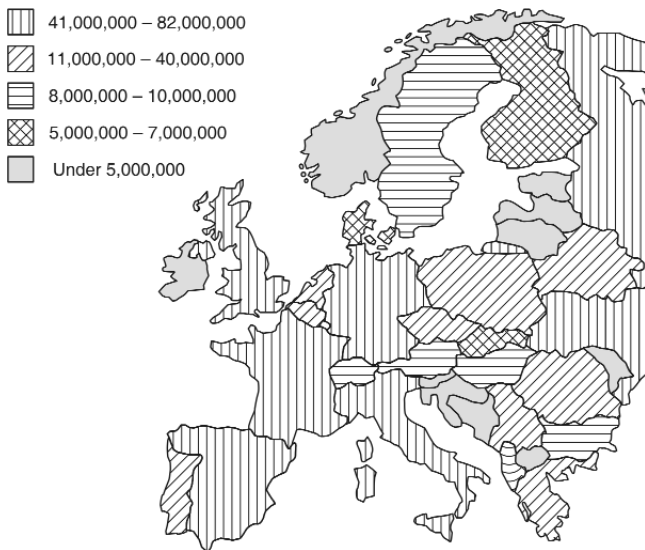

ago: before now, before the present.

increase: amount by which something gets greater.

to increase: to get greater in size.

each: every; all, one by one.

will increase

increase(s)

increased

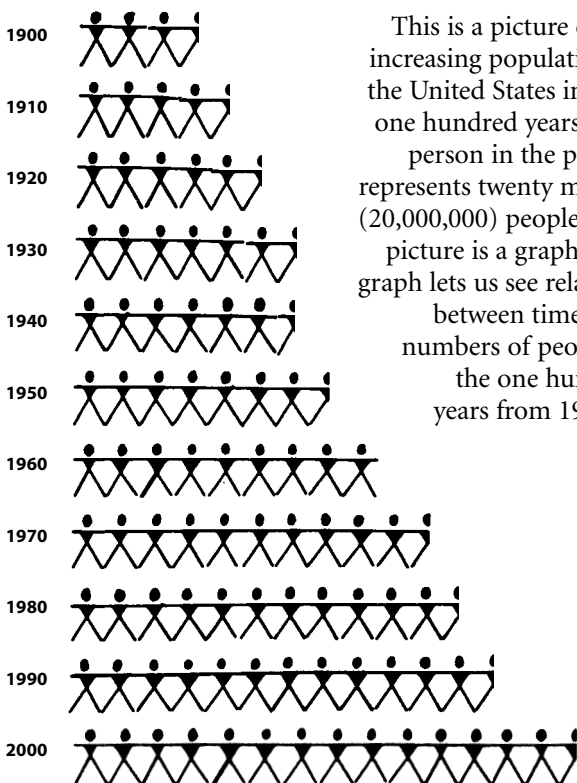

This is a picture of the increasing population of the United States in only one hundred years. One person in the picture represents twenty million (20,000,000) people. This picture is a graph. This graph lets us see relations between times and numbers of people in the one hundred years from 1900 to 2000.

represents: takes the place of; puts before the mind.

graph: picture which represents changes in amounts in relation to other changes.

relation: there is the same relation between 2 and 4 as there is between 3 and 6.

will represent

represent(s)

represented

This map gives a picture of the population in the different states of the United States of America in 2000. The scale of the map is the same as that used for Europe on page 9.

If you look at the two you will see that the U.S.A. is not much smaller than all of Europe.

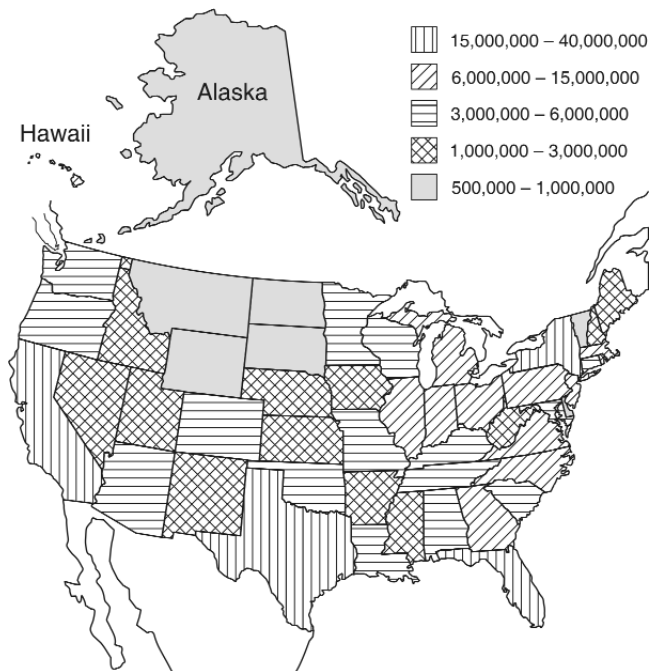

scale: one inch on this line represents a mile. The scale used is one inch to a mile.

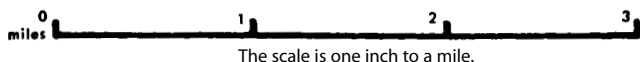

look: take a look.

will look

look(s)

looked

Which are the countries with the most people in them? China, India, the U.S.A and Indonesia all have populations of over two hundred million. Some countries have less room in them than these four, but these have the greatest populations.

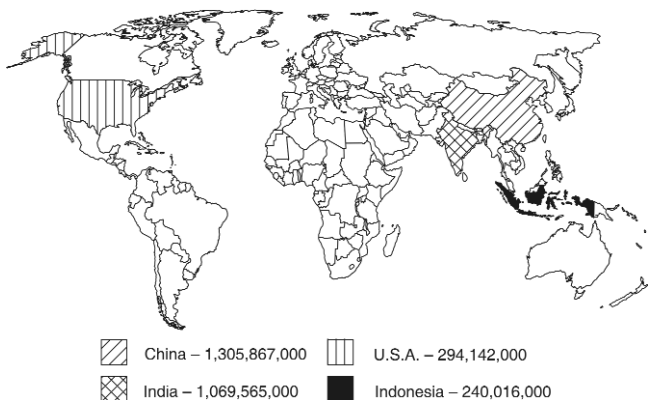

It is not good for a country if it does not have enough room for all its people. A person who does not have enough room to live in may not be able to keep well.

over: more than.

room: when there is no more room in a room, in a building, in a country, it is full.

well: people are well if there is nothing wrong with their bodies or their minds.

The population of the earth has increased more than the amount of food. There is a great need for more food. More than a billion people on the earth today need more food than they can get. They cannot get enough food to keep them well and strong. The relation between amount of food and size of population has been changing.

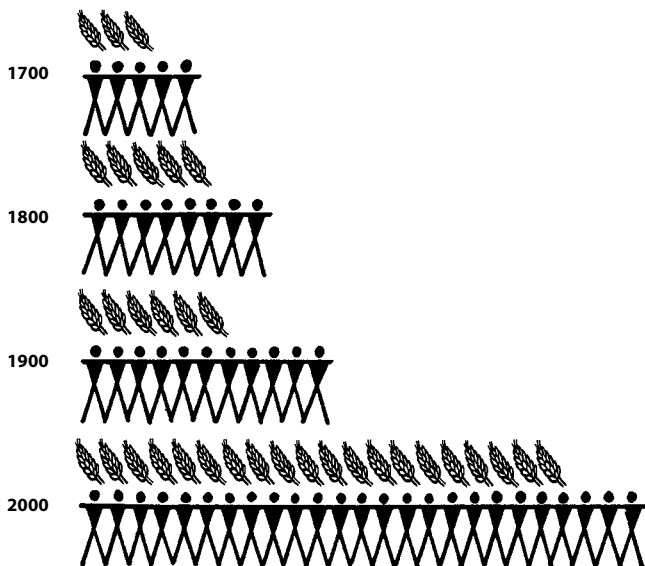

a billion: in American numbers, a thousand million, 1,000,000,000.

need: something important which is not present.

can: are able to.

cannot: are not able to.

will need
(will be able to)

need(s)
can

needed
could

There were more than twice as many people in the world in the year 1900 as in 1700. There were more than twice as many in 2000 as in 1900.

Will the population of the world go on increasing? Look at the curve in this picture.

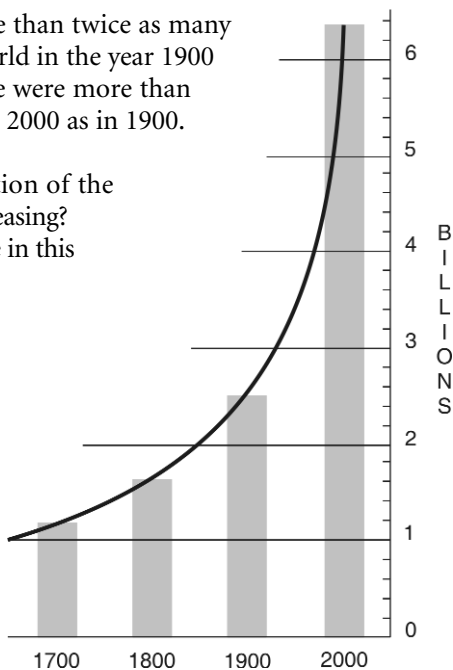

The increase since 2000 makes it look that way. The world population in 2004 was 6,396,000,000. In the last four years the increase has been almost 300,000,000.

twice: twice a thing is two times it.

world: the earth and all that (which) is on it—people, other living things and the things that people have made.

curve: line that goes on changing its direction.

There were over six billion one hundred million (6,100,000,000) people in the world in 2000. Over one billion of them could not get as much food as they needed. Many of them because of this are not healthy.

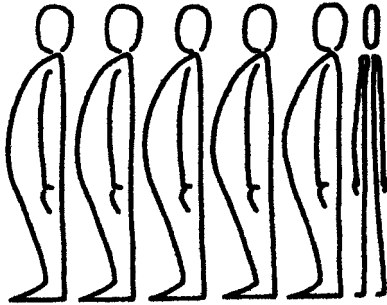

There are some people everywhere who take more food than is good for them, but many more get less than they need.

People are asking one another what the world population will be in 2050 if it goes on increasing like this. It will be very great. It will be much greater in some parts of the world than in others.

Some people say it will be between nine and ten billion, and some that it may be as much as twenty billion.

healthy: well, right in body and mind.

everywhere: in every place.

Over half a billion people on earth today live in cities. Some cities have many more people in them than some countries have.

There are over one hundred cities in the world which have over two million people in them.

Cities have been increasing in size in our time. Before the twentieth century it was hard for the people in a great city to get enough food.

On the next page you will see the names of twenty cities in the world with more than three million people in each.

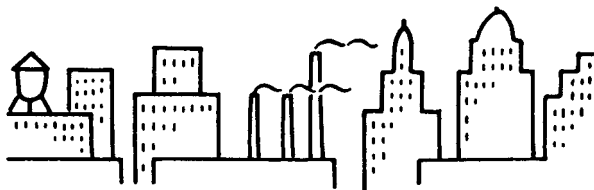

city: town of great size.

twentieth century: the hundred years numbered from 1900 through 1999.

next: the next page to page 16 is page 17.

Cities of the world with population of over eleven million in 2004.

1.	Tokyo (Japan)	29,900,000
2.	Mexico City (Mexico)	27,800,000
3.	Sao Paulo (Brazil)	25,300,000
4.	Seoul (South Korea)	21,900,000
5.	Shanghai (China)	17,000,000
6.	New York (United States)	16,300,000
7.	Bombay (India)	15,300,000
8.	Beijing (China)	14,600,000
9.	Los Angeles (United States)	14,300,000
10.	Osaka (Japan)	14,300,000
11.	Tehran (Iran)	14,200,000
12.	Rio de Janeiro (Brazil)	14,100,000
13.	Calcutta (India)	14,100,000
14.	Buenos Aires (Argentina)	12,900,000
15.	Manila (Philippines)	12,800,000
16.	Jakarta (Indonesia)	12,800,000
17.	Lagos (Nigeria)	12,500,000
18.	Cairo (Egypt)	12,500,000
19.	Delhi (India)	11,800,000
20.	Karachi (Pakistan)	11,300,000

Today more than half the population of the world is made up of people living in great cities.

This city has great buildings, some of which have machines in them for doing many sorts of work by steam or electric power. These are factories. One of them is a factory where furniture is made. In it workers make tables and chairs in great numbers.

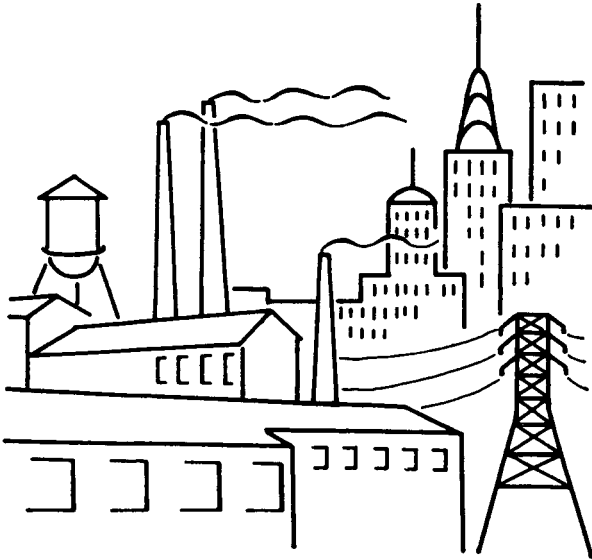

worker: person who works.

machine: instrument which does work for workers.

power: a thing's power is the work it is able to do.

electric power: power which gives us electric light, heat, etc.

factory: building where workers and machines make things.

furniture: beds, tables, chests of drawers, bookshelves, etc.

chair: seat for one person.



We are living at a time when machines do work which workers used to do. Now materials and things of all sorts can be transported long distances quickly. Its transport lines are very important to any great city.

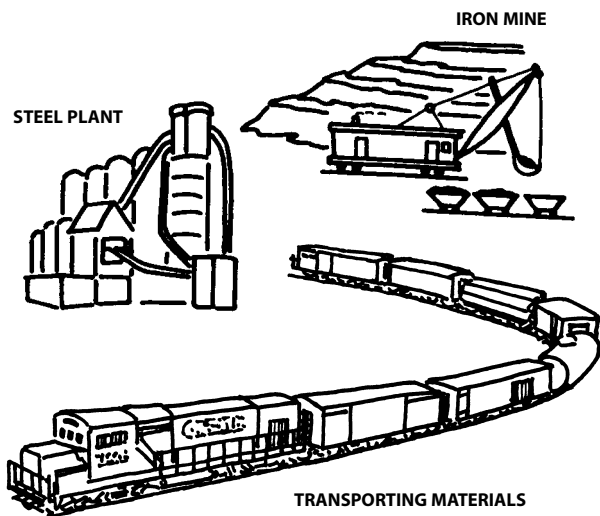

Materials such as iron, which is mined from the earth in some places, and steel, which is made from iron, are used to make machines. Iron and steel are metals.

material: that from which things can be made. Wood is a material from which much of our furniture is made. Glass is the material used in windows. Much of our clothing is made of wool or cotton or silk materials. Machines are made of metal.

any: in this sense, every.

plant: in this sense, factory.

metal: any material of a certain sort, such as iron and steel. Metals are hard and are got from the earth.

It is only in the last two centuries that great numbers of people have been able to live far from their food supply, with thousands of people in one place doing the same sort of work.

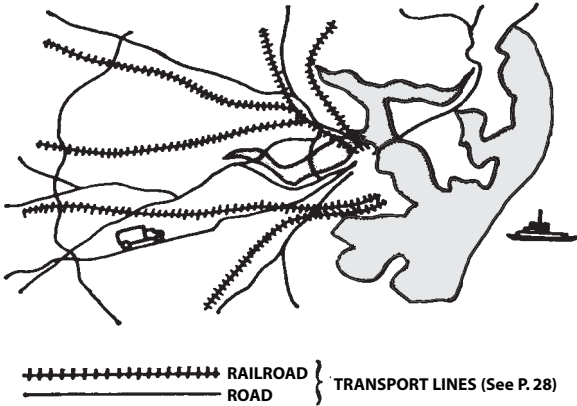

High buildings like those pictured on the next page are being put up in more and more great cities today in greater and greater numbers. They are apartment houses, which sometimes have hundreds of different families living under one roof. There may be as many as twenty or thirty floors in one apartment house, with homes for fifteen or twenty families on a floor.

supply: amount of something for future use.

food supply: amount of food needed.

apartment house: building for a number of families to live in.

home: living place for a family.

Hundreds of families may make their homes in one apartment house.

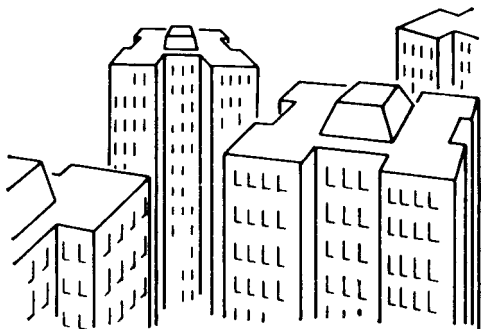

In these stores people who live in the city can buy food, clothing and supplies of everything they need.

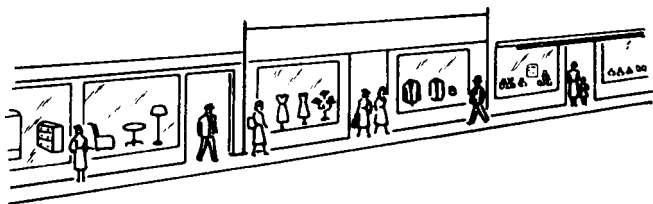

Some stores sell food, some sell clothing and some sell furniture. In most cities there are great stores which sell almost everything. They supply these families with what they need.

buy: get something by giving money for it.

sell: supply for money. If I buy something from you, you sell it to me.

supply: give a supply of.

will buy
will sell
will supply

buy(s)
sell(s)
supply(ies)

bought
sold
supplied

People in apartment houses have no place to keep a supply of food. They may have enough food in an icebox to take them through a day or two,

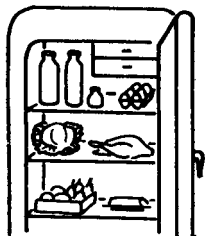

but on most days they buy meat and milk and fruit and other things they need from a store near their home.

Many families have supplies of milk and other foods sent to their houses every day. People with children in the family may buy four or five quarts of milk at a time.

Here is a family with five persons in it: a husband, a wife and their three children.

The man is the woman's husband and she is his wife. They have been married ten years.



child: a baby or a young boy or young girl. Young boys and girls are children.

quart: see next page.

married: husbands and wives are men and women who are married.

A milkman put the milk outside their door in the early morning. Milkmen started their work in a great city before it was light.

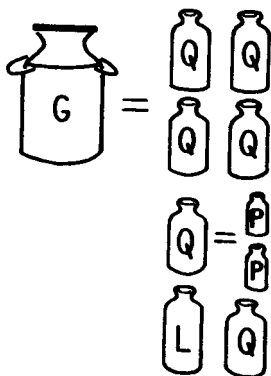
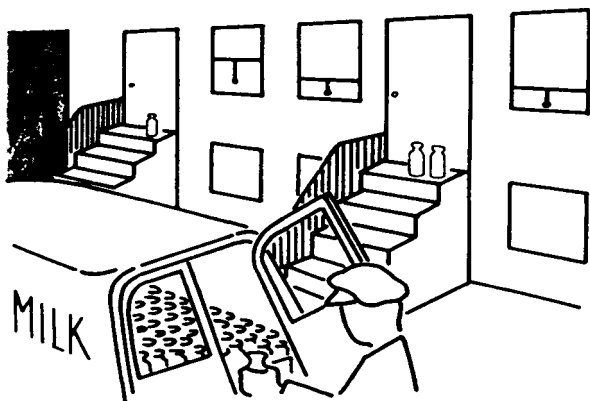

In some parts of the world milk is measured in gallons. Milk is put up in pint and quart bottles or in cartons. In other parts of the world milk is measured in liters. A liter is a little more than a quart.

pint: about two cupfuls.

gallon: four quarts make one gallon; two pints make one quart; there are two cups in a pint.

early: the first hours of the morning are the early morning.

carton: bottle or box made of strong paper material.

will start

start(s)

started

In some factories food is put into cans. It is canned. These are machines in a canning factory.

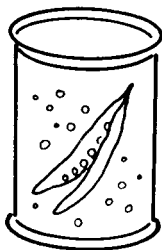
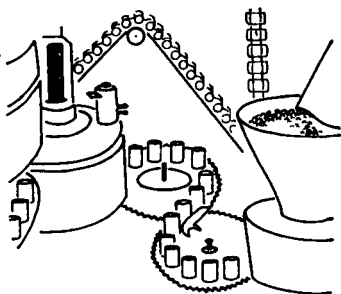

Most foods today can be bought in cans. Food stores sell canned soups, meats, fruit and vegetables.

Food is canned to keep it from the air. When air can get at it, it quickly goes bad—if it is not kept very cold.

Canned food that has gone bad is a poison. Bad food is very bad for people; it poisons them. If they take much of it they may die. After a person dies, he is dead.

can: metal box. A can can keep food good for years. In Britain a can is a tin.
Tin is a metal which is used as a coating for cans.

vegetables: plants used as food.

poison: anything which is very bad in its effect if taken by mouth.

die: come to the end of living.

dead: no longer living.



will poison
will die

poison(s)
die(s)

poisoned
died

People can have only a few cans of meat and fruit and other things “on hand,” as we say, on their shelves. They may have a cupboard with two or three shelves of canned food, but most people have no room for more than that. If supplies do not come into the city day by day their supply of canned food is quickly used up.

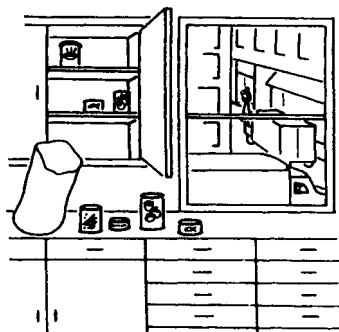

Many solid and liquid foods are kept in cans. Gas for cooking can be canned and piped to the gas cooker from the can for use.

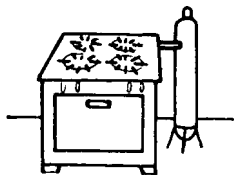

can't: cannot.

few: a small number of, not many.

cupboard: walled-in shelves with doors in front of them.

gas: material which is not solid and not liquid. All material things are solids, liquids or gases. There are many different gases, only a few of which are used for heating.

Some people working in cities have no time or place to cook for themselves. Many of them go out to restaurants for all of their meals. There are many restaurants in a great city, all needing supplies of food every day and some of them cooking for great numbers of people.



A good restaurant keeps its food clean and does not let flies get at it. If flies get on food they may poison it.

cook: do cooking. A cook cooks.

themselves: himself and herself.

meal: food taken at one time, in the morning (breakfast), in the middle of the day (luncheon, lunch or dinner) or at night (dinner or supper).

restaurant: place where you can take meals at different prices.

fly: this is a housefly.



will cook

cook(s)

cooked

Here is a supply of meat, vegetables, milk, butter, cheese, bread, fruit and eggs, enough for a family of four persons for one day in North America. If people do not get enough food of the right sorts, they will not keep well. They will not be able to work or play well. (See *EP 2*, pp. 108–112 and 153.)

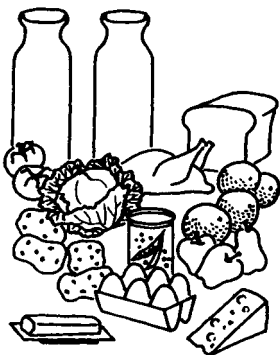

Fresh food must be supplied to a city day by day. It will not keep good very long if it is open to the air. If uncovered, it may get flies on it. Flies get on dirty things. Their dirty feet make food dirty. Canned food will keep good for a long time. It can be stored.

fresh: new, not kept for a long time.

must: has to. A person must have air, water and food to live.

uncovered: not covered. See pages 36, uncooked; 64, unlike; 81, unchanged; 83, unconscious; 88, unwell.

stored: kept for use when needed.

will store
will work
will play

store(s)
work(s)
play(s)

stored
worked
played

Grain and meat and milk and fruit and vegetables must be transported into the cities of the world day and night all through the year to feed its city populations. Much of this food comes great distances in ships, trains, or trucks, and must be kept cold and clean all the way. Today some of it is transported by plane.

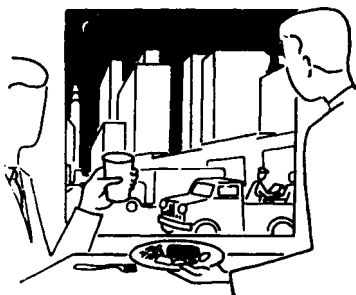

This is a bag of grain.



grain: seeds of some grass plants used for making bread and some other cooked foods.

feed: when we give people food, we feed them.

truck: road transport for goods.



will feed

feed(s)

fed

The nineteen million people in and near New York City in 2004, to give one example, were drinking seven million quarts of milk a day from more than a million cows on fifty thousand farms, some of them hundreds of miles away. The price of a bottle of milk in the city is more than twice as much as the farmer gets for it. The milk must be kept clean and cold and put into bottles and taken to the stores and houses in the city. City governments see that milk is kept clean and has enough butterfat in it.

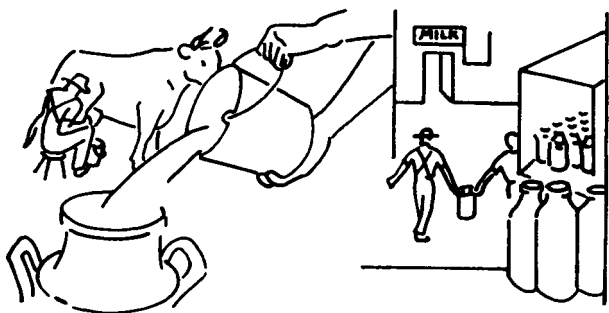

Some city-born children have never seen a cow and have to be taught where milk comes from.

example: one of a number of things which are being talked about together. New York is an example of a city which must have food transported to it.

away: off, from that place (see *EP 2*, p. 149).

fat: the part of milk from which butter is made is butterfat. There are many sorts of fats.

never: not ever.

will teach

teach(es)

taught

Milk is the best food there is for babies. It is good for children and for older people too. It has in it fat, which gives energy, and it has the most important of the materials needed for building up our bodies. Milk makes strong bones and strong teeth too. It is good for a child to drink two or three glasses of it every day.

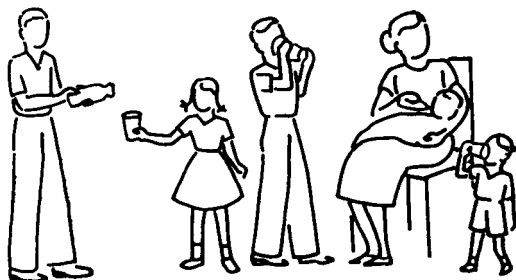

In addition, milk has in it most of the vitamins which are needed to keep us healthy. Vitamins are a discovery of the twentieth century. Two hundred years ago no one knew anything about them.

too: in addition. After the addition of one thing to another we have the one and the other too.

energy: power.

build: putting up a building is building it. We can build houses with wood and bodies with food.

drink: take in by mouth, take a drink.

know: have knowledge of.

will build

will drink

will know

build(s)

drink(s)

know(s)

built

drank, drunk

knew, known

The vitamins are named by letters of the alphabet. Vitamin A is needed by the eyes. There is Vitamin A in milk, butter and green vegetables. It can be stored by the body.

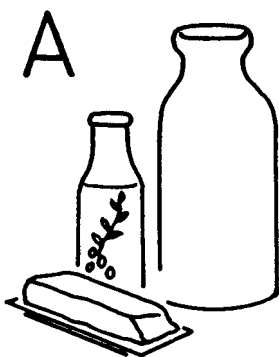

Vitamin B cannot be stored. It must be supplied all the time by some of the food we eat. The skins of grain of all sorts have Vitamin B in them.

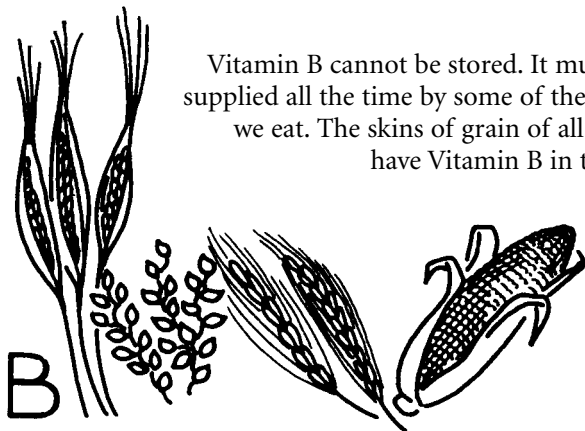

alphabet: all the letters used in writing (see page 61).

eat: take food by the mouth.

will eat

eat(s)

ate, eaten



Vitamin C is very important to the body. Without it our teeth become loose and our arms and legs weak. Lemons, oranges and tomatoes have Vitamin C in them.

Vitamin D is the sun vitamin. We get it in milk and eggs and from sunlight on our skin. There are other vitamins, but these, A, B, C and D, are the most important.

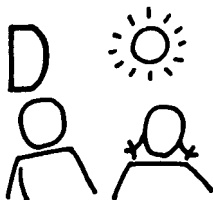

without: not having.

become: come to be.

loose: not strongly rooted; not supported or kept in place.

weak: opposite of strong.

lemon: yellow fruit like an orange but not sweet.

tomato: a red or yellow fruit used as a vegetable.

become

become(s)

became

Every person must have air and water and food to keep alive and must have these vitamins to keep well.

How do we know this? How do we know what food keeps us well and healthy? We know from the effects on us and on animals of going without one sort of food or another. That is how we see which foods give us energy, which make us fat and which make us able to keep healthy.



Scientists are putting together more and more knowledge about the sorts and amounts of food that our bodies need. Too little food or too much of the wrong food is bad for a person. The right amount of the food will keep a person feeling well and strong.

Some people need a little more or a little less of one or another sort of food than others.

alive: living.

going without: not getting.

scientist: man or woman of science.

too little: less than enough, not enough.

too much: overmuch, more than enough.

Where do we get our food? We get much of it from the earth. We use some sorts of animals and birds to give us food.

Great parts of the earth are covered with grass, a plant which grows with narrow green leaves and puts down roots quickly. There are more than three thousand different sorts of grasses growing.

Grass has very small seeds which are used as food by birds and small animals. We have discovered how to grow grasses with larger seeds.



Wheat, rice, corn, and other grains come from grass. The grain lands of the world have been planted by people. From grain we get an important part of the food that gives us energy.

discover: make the discovery of, get to know.

large: great in size (large, larger, largest).

grow: come up from seeds in the earth, get larger.

will discover
will grow

discover(s)
grow(s)

discovered
grew, grown

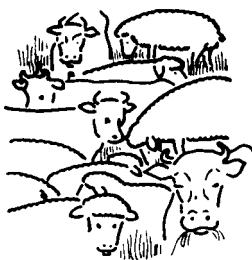

The grasslands of the earth supply food to many different animals. From some of them we get meat and milk. From milk we make butter and cheese and other foods.

From birds living on grain we get eggs and meat.

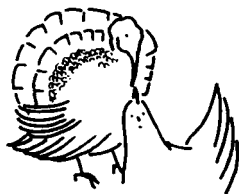

Seeds planted in good earth supply grains and fruits and vegetables of many sorts.

The seas and rivers supply fish and some sea plants for food.

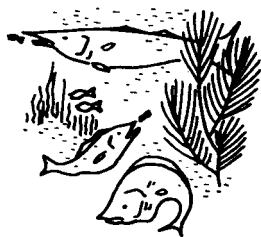

fish: water-breathing animal.

People had to go from place to place for food until they discovered how to grow grain. Uncooked meat and parts of plants were all they had to eat until they made use of fire. And they had to get new supplies of food every day. They hadn't any way of keeping it good.



How could a family get enough good food for itself without having to go looking for it every day?

When a family started growing grain, it had time to do other things than get food day by day. It could keep a supply of grain on hand through the winter until the next spring. It could make a home for itself and keep animals for its use.

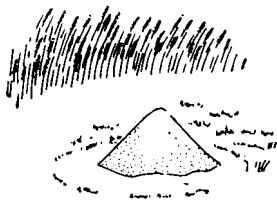

until (till): up to the time that.

Bread, which is made from flour, supplies us with energy and is the chief food of many people.

A small amount of seed planted in the earth can grow great amounts of good grain.



A good farmer in a good wheat-growing part of Canada, for example, will get as much as thirty or forty pounds (lbs.) of grain for every pound of seed he puts into the earth. Farmers grow grain for public use. They get money for it.

In eastern countries more rice is eaten than wheat.

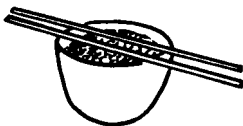

flour: a soft powder made from crushing wheat or other grain.

pound: measure of weight. One pound (1 lb.) is a little less than half a kilogram. One kilogram (1000 grams) is a little more than two pounds (2.2046 lbs.).



public use: use by anyone. The public are the people.

eastern: in or of the east (-ern may be put on the end of north, south or west in the same way).

If there were enough good food in every country every day for every person, would the world be a better place than it is?

We say, “If there *were* enough food,” not, “If there *is* enough food,” because there is not enough, and we know it.

We say, “If there were something in this hand you would see it,” because we know that there is nothing in the hand.



But with this hand, which is shut, we say, “If there is something in this hand you will see it.”



Now the hand is open. There is something in it and you do see it.



If we asked the question, “If there were enough good food for everybody, would the world be a better place?” some people would answer: “Yes, the world would be a better place.” Others would say, “No, nobody would do any work! The world would be a worse place.”

And some others would say something like this: “That is a strange question to ask when so many people in the world today do not get enough food. There will be time to answer your question when we have grown enough food for everybody.”

What would your answer be?

everybody: all persons, everyone.

nobody: no person, no one, not anyone.

would: if this line from A to B were straight, then it would be the shortest distance between A and B. But the line is not straight. That is why we say *were* and *would* in this example.



Why do people work?

Do they work only for their private needs—because of their need for homes and food and clothing for themselves and their families?



Why do some people work when they have enough of all these things? Do they work for pleasure, because making things, for example, gives them pleasure? Do some of them work for the public good? Why are some people happier when they are working? Isn't work one of their needs?

Why do you work? Do you need to work to be happy?

Do we know one another's needs? Aren't we in the dark about some of them?

private needs: needs of one person or of a small number.

public good: good of all.

isn't: is not.

aren't: are not. When *isn't* or *aren't* starts a question in place of *is* or *are*, we are looking for the answer "Yes."

in the dark: people aren't able to see in the dark.

If all the people alive on the earth today were hand in hand like this, the line they would make would go much more than fifty times round the earth.



The line of people would go out to the moon and back five times. It would be long enough to do that.

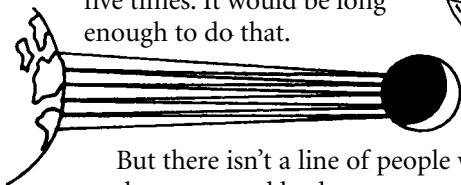

But there isn't a line of people which goes out to the moon and back.



And the people of the earth aren't hand in hand; far from it!

That is why we said "*were*" (not "are") and "They *would* go" (not "they go").

We say: If the angles in this triangle are equal, then the sides will be equal.

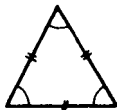

But we say: If the angles in this triangle *were* equal, the sides *would be* equal.

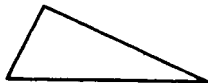

triangle: this is another triangle.



People are not hand in hand, but their minds today are being put increasingly into touch with one another through reading and writing and in many other ways.

We are in touch with other people everywhere through pictures of them. Newspapers and television give us photographs of almost everything. The faces of important people can be seen by the public everywhere.

Before 1800 nobody could take photographs. Nobody had had the idea of using the knowledge of how light is bent by glass (See *EP 2*, pp. 103-106) to make pictures.

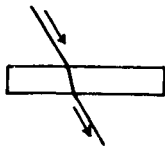

Here is a camera which is taking a picture of a man.

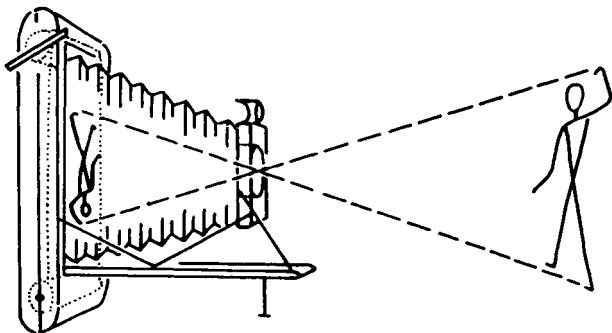

You will see that the picture inside the camera is upside down.

increasingly: more and more.

photograph: picture taken with a camera.

camera: instrument for taking photographs.

Another way in which people are getting to know more about one another is through the radio. Words were first sent from one place to another by telephone more than a hundred years ago. A word can now go by telephone from the Atlantic to the Pacific in one-twelfth ($\frac{1}{12}$) of a second. A telephone needs wires, but the radio, which came into use almost one hundred years ago, can send sounds any distance without wires.

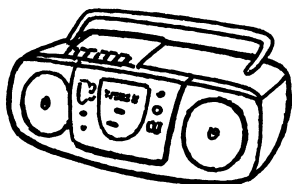

Television (TV), which is one of the great new powers—for good or bad—of our time, lets a public person talk to millions while they sit in their private homes seeing the person as if standing right there in front of them.

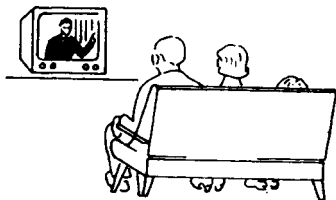

wire: thread of metal.

talk: say things.

sit: be seated. When you take a seat on something, you sit on it.

telephone, radio, television: see pictures on this page.

will talk

will sit

talk(s)

sit(s)

talked

sat

But people can't know what any person is saying if they don't know the language.

Up to a hundred years ago few people needed to learn foreign languages because not many people went into foreign countries.

Now, the need to learn other people's languages is becoming greater every day.

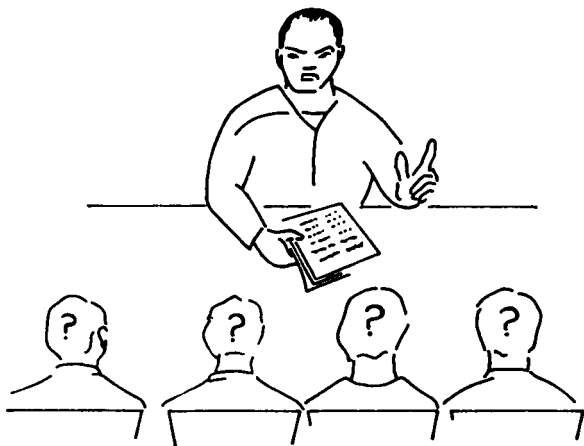

learn: get knowledge of; be learning.

foreign language: a language different from the language of your family.

foreign country: a country which is not yours.

will learn

learn(s)

learned, learnt

Today millions of people, young and old, go into foreign countries every year on business or for pleasure.

One can see babies in baskets being taken about by air every day.

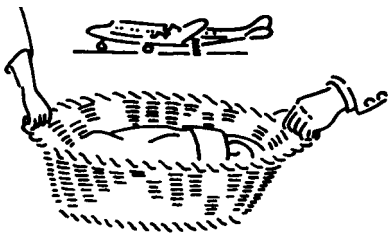

That is a quicker way to get about than on one's mother's back. Here is a woman who is carrying her baby on her back. She carries the child with her wherever she goes. In the last hundred years people have learnt to go over land and sea through the air as almost all birds and many insects can. People are carried through the air in airplanes.



one: a person.

one's: a person's.

carrying: taking from place to place.

Insect: these are insects.

will carry

carries



carried

Some birds have eyes which can see great distances, and they have good hearing. Some of them can hear sounds which we cannot hear.



But people have made themselves new ears and new eyes.



Today one can talk with a person at the other side of the earth by telephone. Through the radio one can hear sounds which come through space from thousands of miles away.

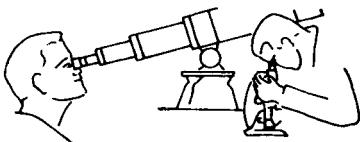

One can see through a telescope the mountains on the moon, and, through a microscope, thousands of living things in a drop of water.

hear: take in sounds, use the sense of hearing.

space: distance between things; that in which all things are.

will hear

hear(s)

heard

Hundreds of millions of people today can see and hear on television and the radio important statements by public people, statements which in earlier times could have been heard by few. It is a question whether at any time in history one has been able to be heard by millions of people at the same time. Without the telephone, television and the radio a person can only be heard as far as the voice can carry.



New instruments are making our homes less private and public men and women more public. No one knows what will come of this. One of the worst effects is that singers who are no singers and noisemakers of every sort can be heard in too many places.

whether: if or not.

history: our past as we know it; the account or story of it.

voice: sound made through the mouth; the power to make such sounds.

sing: singers sing songs.

will sing

sing(s)

sang, sung

Birds and many insects have wings. It is their wings which take them up into the air. The wings of birds have long feathers on them. Their bones and the stems of their wing feathers are hollow. This keeps them light.

Here is a bee.



Here is a beetle.



Here is a fly.



And here is a butterfly.



Bees, beetles and flies are insects.



There are very many different sorts of insects.

wing: a bird has wings where a person has arms and a dog or horse has front legs.

feathers: these are feathers:



hollow: with space inside as in a pipe or in a ball which is not solid.
light: of little weight.

People have been attempting for thousands of years to make wings that will let them fly like the birds.



Here is the picture of the first flying machine to take men into the sky, made in 1903. It did not fly very fast or very far.

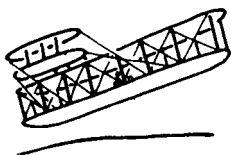

Now airplanes can fly farther and faster than the fastest bird and can carry heavy weights through the air. People can go faster than sound in the newest planes.

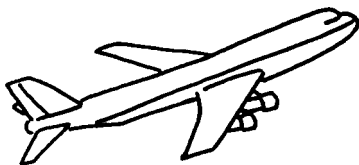

heavy: of great weight; opposite of light.

fast (faster, fastest): quickly.

fly: go like a fly through the air.

will fly

fly(ies)

flew, flown

We can see why distances between people are not as important now as they were. They may be bridged in so many ways.

What is a bridge? Here is a wide river with a bridge over it. The bridge is more than a mile long and is made of steel. It can carry very heavy weights. It is so strong that not only automobiles but trains go across it. It is so high that great ships go under it.

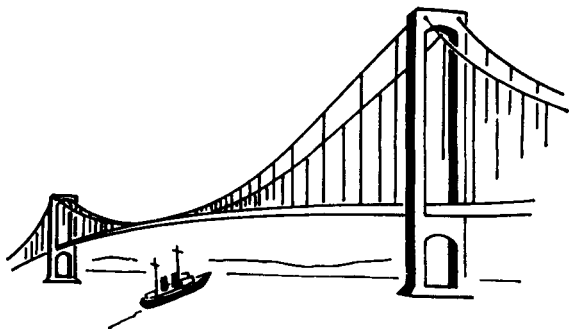

Language is a bridge between minds, a bridge so strong that trains of thought can go across. Language can bridge distances.

so: in this sense *very*.

so strong that: strong enough to let.

so high that: high enough to let.

will bridge

bridge(s)

bridged

Language can bridge time as well as space. Ideas can go from mind to mind across the language bridge, and they can come from the past to the present. We can read what people before us wrote and keep their books for others to read in the future.

Here are some of the great books of all time.



Books are the most important records we have of people's thoughts and feelings, their ideas and desires.

read: do reading.

write: do writing.

past: what has been before now (see *EP 2*, p. 157; *EP 3*, p. 1).

present: here and now.

future: what will be.

record: store of knowledge. From records we can learn what was done in earlier times.

will read
will write

read(s)
write(s)

read
wrote, written

All people have more in common with all others on earth than most of them know. What do the words “in common” mean? What is their meaning? What do the people in this family have in common? They have their



family name in common. They are the Smiths, or the Wangs. They have a house in common; it is their home. The husband and wife have their children in common. In some parts of the world a man may have a number of wives. In other parts a woman may have a number of husbands. In these

countries the wives have their husband in common or the husbands have their wife in common.

People of the same country have that country in common. It is their country. Every country has a flag. What is the flag of your country?

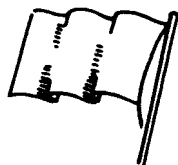

meaning: sense. What words say to us is their meaning, what they mean.

flag: see picture on this page. Your flag represents your country.

will mean

mean(s)

meant

People who talk the same language have that language in common. It is their language, the language of each and all of them. They have the ideas and feelings about things which that language carries.



People who do not talk a language do not know what those who use it are saying. They do not know what its words can mean. They have less in common with those who talk it than those people have with one another.

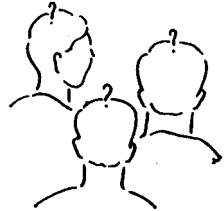

Sometimes, as in India, in one country under one flag people talk many languages. They have their country and their flag in common, but some of them have to learn the language of others if they are to have a language in common.

Talking with someone is saying things to him, hearing what he says and taking in his meaning. People can talk

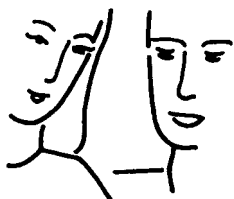

together only when they have a language in common. When you were very young your parents talked to you and after a time you saw what they meant and learned to talk to them. A baby's first words are commonly names for its parents. Some children learn to talk earlier than others.



We go on learning our language all our lives.

Some people talk more than they think, and some people think more than they talk. Most of our thinking is done through language.

parent: father or mother.

commonly: most times. It is common for babies to say names for their parents first. Babies have this in common.

think: have thoughts, use the mind, have ideas.

will think

think(s)

thought

There are more than six billion people on the earth and about 2500 languages. Of these languages only about twelve are used by more than 50 million people.

Here are the names of some languages which have very wide use: Chinese (Mandarin and Cantonese), English, French, German, Hindi, Japanese, Russian, Spanish, Portuguese, Arabic and Bengali. All these languages have more people talking them today than ever before. Two hundred years ago there were only about twenty million people who talked English, for example. Now there are about five hundred million, and there may be many, many more.

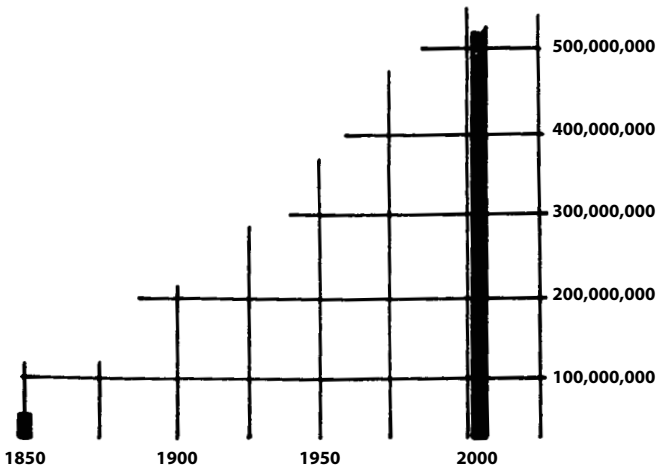

at least: that number or more.

More people will learn more languages as better ways of teaching them are worked out.



This book, *English Through Pictures 3*, is itself part of an attempt to teach English better.

We need better books to learn from and better recordings of good voices to teach us how to listen to the sentences of a language and say them.

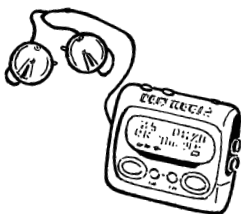

Recordings of sounds are made on CDs, disks and on tapes.



listen: attempt to hear.

attempt: make an attempt.

record: records or recordings, when played on a machine, let us hear again the sounds recorded on them.

sentence: a thought put in words. A written sentence starts with a large (capital) letter and ends with a full stop (period) or sometimes a question mark.

CD: a small plastic disk on which information or music is recorded.

disk: a flat circular object which is used for storing computer information.

tape: long narrow roll of plastic, thin cloth, paper or other material.

will listen
will attempt

listen(s)
attempt(s)

listened
attempted

We need good pictures to teach us meanings in the new language and good motion pictures to help many more people to learn languages quickly and well. The learners will then be able to work in groups with the help of teachers or by themselves, using books, records, radio, CDs, sound motion pictures and television.

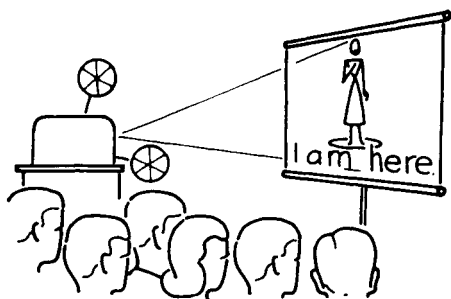

A teacher can help a learner to learn. Reading and writing can help us to think.

well: in a good way.

help: something which does part of our work for us. A stick may be a help to an old man; it may help him.



in groups: together with others.

group: those doing something together or having something in common.

will help

help(s)

helped

Writing is a very much newer invention than talking. Nobody knows when people first began to talk, but they did not begin to write, so far as we know, until seven or eight thousand years ago.

IN EGYPT

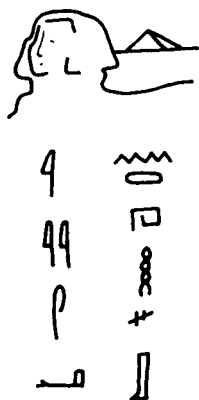

IN MESOPOTAMIA

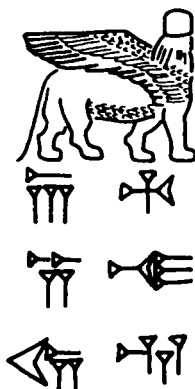

IN CHINA

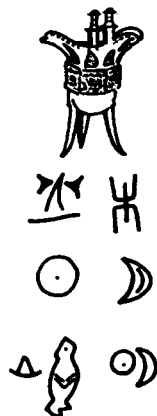

In Egypt, Mesopotamia, and China, and later in Palestine and Greece, people began to make marks and pictures with sticks and sharp stones from which others, or they themselves, later, could see what they had thought.

invention: some new thing or a new way of doing something worked out by people.

began: started.

sharp: cutting.

stone: a hard material, or a bit of it. Much of the earth is made of stone. Some stones are round and smooth from being rolled about by water. Others are sharp and early men made them into knives.

later (late, later, latest): opposite of earlier (**early, earliest**).

will begin

begin(s)

began, begun

These early records were the beginning of writing. The first writing was picture writing. Here are some early Chinese picture words. Can you see what they represent?



Later Chinese writing is less like pictures than the earlier writing was but we can see the pictures in some of its words. For example:

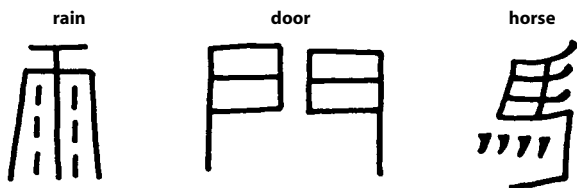

Here are some Egyptian words in picture writing.

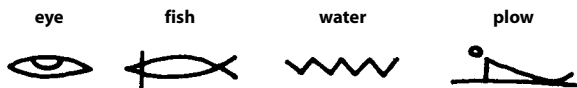

In picture writing, each picture represents a word; you need a different picture or mark for each word.

In present-day Chinese writing most of the marks are not pictures of anything, and a reader has to learn how the Chinese write about two thousand of these words before being able to read a newspaper.

With some of these marks you may be able to see what the idea is. For example:

The sun and moon. 明

Its meanings is: “bright” and “open.”

A man and two marks. 仁

One of the meanings is “humanity.”

Learning to read Chinese is much harder than learning to read English. But in word-writing like Chinese the same marks can be read as having the same meaning in different languages; for example, in Mandarin, in Cantonese and in Japanese.

In time some people discovered how to represent the sounds in words by marks. In any language there are only a small number of different sounds. By writing down marks to represent sounds, not ideas, people can spell any of the words in a language with only a small number of marks. Every written language today has its spelling system. The hardest languages to spell are those in which—as with English—many of the letters may represent more than one sound.

Here is the complete Roman alphabet in which English and many other languages are written.

A B C D E F G H I
J K L M N O P Q R
S T U V W X Y Z

Something written in English has a meaning only if it is read as English, because the letters in English represent English sounds. What is written in Italian must be read as Italian.

spell: put letters together to make words.

system: way parts are put together. Here letters are put together to represent the sounds of a language.

complete: something is complete when all of it is there.

will spell

spell(s)

spelled

Here is the name of the book *English Through Pictures* written in a number of different languages. The names of the languages are given in English.

Arabic	الإنكليزية بواسطة الصور
Bengali	ছবির ভেতর দিয়ে ইংরাজী শেখা
Burmese	ရုပ်ပုံဖြင့် အင်္ဂလိပ် မြေသင် မှည့်
Chinese	英語圖解
Greek	ΑΓΓΛΙΚΑ ΜΕ ΕΙΚΟΝΕΣ
Hebrew	אנגלית באמצעות תמונות
Hindi	तस्वीरों द्वारा अंगरेज़ी
Japanese	絵で見る英語
Korean	그림을 통하여 영어공부하는 방법
Persian	اموحتن زبان انگلیسی از روی عکس
Russian	АНГЛИЙСКИЙ ЯЗЫК В КАРТИНКАХ
Sinhalese	තතුර මගින් ඉංග්‍රීසි භාෂාව ඉගෙනගැනීම
Tamil	ங்களின் மூலமாக ஆங்கிலம் கற்றுக்கொள்ளல்
Telugu	పటములద్వారా ఇంగ్లీషు నేర్చుకొనుట
Thai	เฝ้าฝนภาษาอาบงกฤชกร ๖๒๒๒๒
Urdu	تصاویر کے ذریعہ انگریزی سیکھئے!

Here are the twenty-six letters used in English with the English names for them spelled out after them.

a	ay	j	jay	s	ess
b	bee	k	kay	t	tee
c	see	l	ell	u	you
d	dee	m	emm	v	vee
e	ee	n	enn	w	double-U
f	eff	o	oh	x	eks
g	jee	p	pee	y	wy
h	aich	q	kyou	z	zee or
i	eye	r	are		zed (British)

Some of these letters are used not for one sound only, but for any of two or three or more different sounds. The letter *a* may have the sound of *a* in *bag*, *part*, *again*, *say*, *was*, *any*, or *fall*.

The letter *e* may have the sound of *e* in *bell*, *week*, *older*, *earth*, or *hear*, or it may have no sound but only an effect upon other sounds which come before it. The *a* and the *g* in *bag* have different sounds from the *a* and the *g* in *age*, for example.

Reading English is not as hard as reading Chinese, but it is harder than reading a language in which each letter has only one sound.

Are some of the sounds used in one language very unlike any of those used in another?

Yes. You may have felt in learning English that some of the sounds it uses are strange. But if you do not have a well-trained ear, you will not hear English words as they are heard by an Englishman or an American. You will hear the nearest sounds in your mother language.

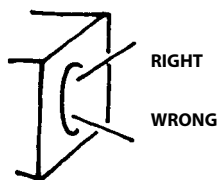

A good way of learning to make the sounds of a new language is to use recordings which have spaces after each sentence giving you time to say what you have heard before the next sentence comes.

may have felt: may have had the feeling.

trained: taught to do something well.

will feel
will train

feel(s)
train(s)

felt
trained

There are machines which will play back to you again and again, one after the other, the sounds you have made and the sounds you were attempting to make. When you hear what you are doing wrong you can try to do better next time.



RIGHT

WRONG

light
long
right
wrong



For most children, new sounds are easy to make when they hear them, and children seem to hear new sounds better and more easily than grownups do. If a family goes to China, or France or Finland (to take three countries whose languages are very unlike one another) the children will learn to talk Chinese or French or Finnish much more quickly than their parents will.

try: make an attempt.

easy: something is easy for you when you can quickly learn to do it well. It is hard when you cannot.

grownup: person who is no longer a child; who has grown up into a man or a woman.

will try

try(ies)

tried

Why is this? Why is it easy for young children to learn languages?

Part of the answer is that children have so many needs. They need to be helped by grownups at every turn. They have to make their needs known and they are always watching the effect of what they say and trying new ways of getting what they want.



Children are learning new things all the time.

watching: looking at. Our watches are things we watch (keep looking at) to see the time.

always: at all times, all the time.

want: have a desire for.

will want
will watch

want(s)
watch(es)

wanted
watched

Another part of the answer is that children are not, as older people sometimes are, fixed in their ways of living. When they are taken about from one country to another they change easily from one language to another, from one bed to another, from one food to another. Older people are more fixed in their ways. They have been hearing and talking one language for a long time. Their ways of hearing and making sounds and of putting words together are like the rails a train goes on. They have been up and down their lines of talk and thought too many times to change them easily.

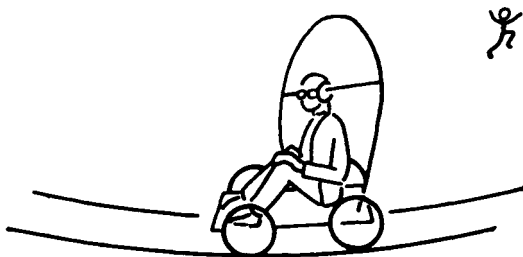

Children are freer in their ways. They are more like an airplane or, better, like a bird; they are free to go in any direction they want. They are free to hear sounds as they are and make them as they hear them. They are free to put new words together in new ways in talking a new language.

free: opposite of fixed.

change: make a change, make changes in.

will change

change(s)

changed

The more languages you hear and get to know, the more you will see how any language is made up of a small number of sounds put together in different ways. For example, in English, *light* and *right* are different words with only one sound in them different. The same is true of *long* and *wrong*.

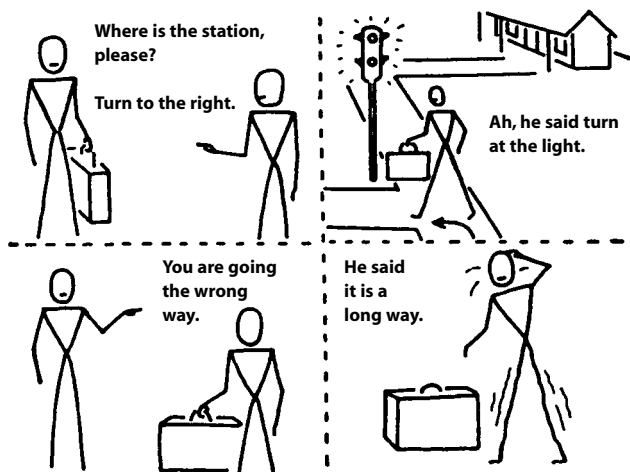

If a learner does not hear these different sounds as different, he may not get the meaning of what is said to him.

turn: make a turn.

ah: a cry not a word.

will turn

turn(s)

turned

There are many ways of helping a learner into a language, but not enough people know them.

Most people learn their mother language without being able to give any account at all of how it works. They learn to talk as they learn to walk, without any idea of how they do it.

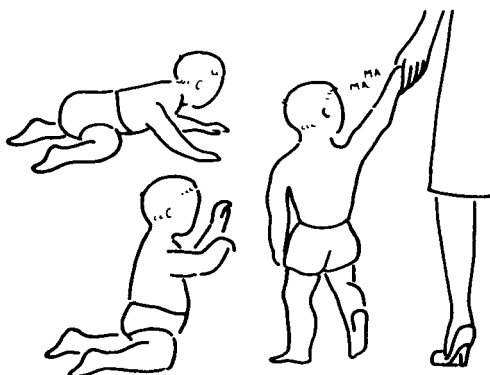

People who learn to use a language well do so through talking with others who use it well, through reading good writers and through watching the effects on others of what they say and how they say it. The world needs more people who can use language well. Language is as necessary to our minds as the air we breathe is to our bodies.

necessary to: needed by.

to breathe: take air in and give it out.

The sound of *ea* in *breathe* is like *ea* in *meal*.

The sound of *ea* in *breath* is like *ea* in *head*.

will walk
will breathe

walk(s)
breathe(s)

walked
breathed

Everybody needs air; we breathe in air from outside our bodies in every breath.



When you put your face under water you cannot keep it there long.

Swimmers can't swim under water very long. They need air.

Good swimmers may swim with their faces in the water; if so, they keep turning their heads to take a breath through their mouths.



Swimmers do not take in air through their noses under the water because water would get in through the nose with the air and go to the lungs. With water in the lungs a person can't go on living.

swim: be swimming.

lung: see top of next page.

will swim

swim(s)

swam

Here is a picture of a man's lungs. They are soft like sponges with thousands of little pipes going through them. The pipes keep branching like the branches of a tree so that they go through every part of each lung.

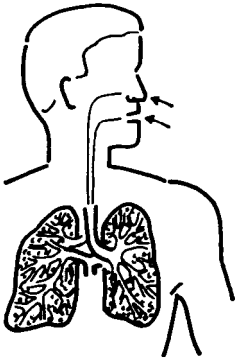
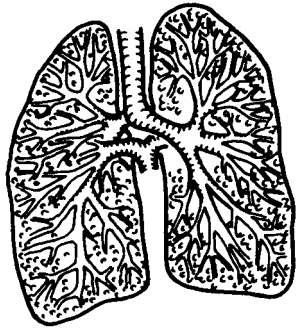

Our lungs are in the upper part of our chest. We have two of them. The air we breathe goes right in to every part of the lungs through these branching pipes. They take it to the blood which is moving all the time through the lungs and round to every part of our bodies. The blood makes a journey round the body and back to the lungs in a very short time.

sponge: framework built up by one sort of water animal as its home; soft in water and used by people for washing.

upper: higher up than the middle.

right in: all the way in.

blood: red liquid in bodies of higher animals.

moving: in motion.



will move

move(s)

moved

What is blood?

It is the red liquid which comes out of your finger when you cut it.

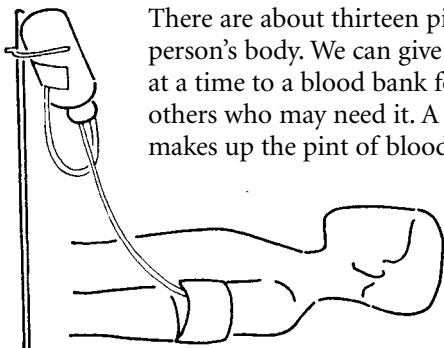

There are about thirteen pints of blood in a person's body. We can give a pint of blood at a time to a blood bank for the use of others who may need it. A healthy body makes up the pint of blood quickly.

What does our blood do for us? It takes food to all parts of our bodies and takes waste away from them. All the parts of our bodies are made up of cells. These cells, which are very small, all need food all the time.

cut: make a cut in.

blood bank: place where blood is kept as money is kept in a bank.

waste: that which is of no more use; materials not needed.

cell: smallest living thing, or smallest living part of living thing.

will cut

cut(s)

cut

Here are some cells, thousands of times the size they are in the body.



Each different sort of cell has its own work to do, different from the work other sorts of cells do.

No one had seen cells before the invention of the microscope and its development in the sixteenth and seventeenth centuries. Before then no one could make pictures of cells because no one could see them.

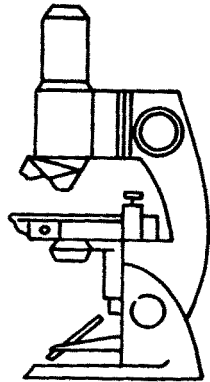

own: a cell's own work is *its* work, not that of any other sort of cell. Your own hat is yours, not any other person's hat.

development: change by which something (living thing, idea, invention) becomes better, or more able to do things. All the animals and plants we see about us have developed from earlier living things which were at first made up of only one cell.

will develop

develop(s)

developed

Cells are like little flames. A flame needs food. We get a quick flame—for a fire or a cigarette—by lighting a match or using a lighter. The flame of the match burns the match and the flame of the lighter burns the liquid in the lighter, if there is air for them to burn in.

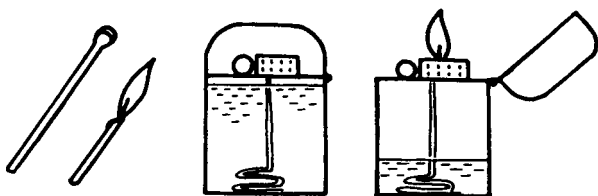

All fires burn something. What they burn is their fuel. Fuel is food for fire.



cigarette: thin roll of cut tobacco in paper for smoking.

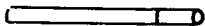

cigarette lighter: box with liquid which will burn in it.

tobacco: dried leaves of the tobacco plant.



burn: be changed by fire.

match: small stick of wood or paper which gives flame.

fuel: material for fire. Fuel may be solid, liquid or gas.

will burn

burn(s)

burned, burnt

The blood is like a stream. The cells take what they need, their fuel, out of the blood stream, as plants and fishes take their food out of water.

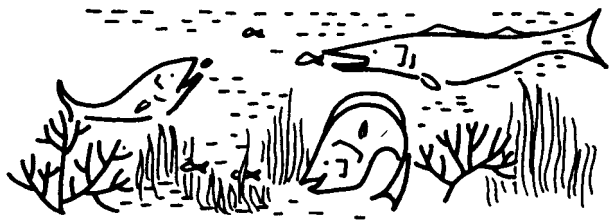

The blood stream carries food and the oxygen which it has taken up in our lungs to all the cells in the body. Old cells die and give place to new cells in the body as plants and fish and other living things in the world about us die and give place to others. Three million of your red blood cells die every second and other cells take their place. The red cell population of your body changes completely in about three months.

stream: river.

oxygen: one of the gases in air. Our lungs take it out of the air we breathe. Fire takes oxygen out of the air as it burns.

What makes the blood go on moving round the body in a stream?

The heart sends it round.

The heart is between the lungs. A person's heart is the size of his shut hand.

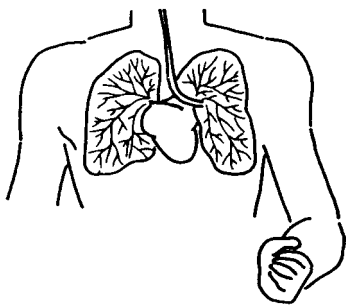

The heart is a pump. If you put your hand under water like this, and keep letting a little water into it



and sending it out again, you are pumping the water. The heart pumps blood in a way a little like this.

pump: machine for pushing liquid or air or gas in or out of something.

will pump

pump(s)

pumped

The heart has four rooms in it with doors (valves) between them. It pumps blood in and out through these doors by changing the size of the rooms so that the doors open and shut. It can do this because it is made of muscle.



The heart keeps a stream of blood going all round the body and back again to itself. The pipes which take blood from the heart are named *arteries*; the pipes through which it comes back to the heart are named *veins*.

valve: opening which lets liquid or gas go through one way but not the other way.

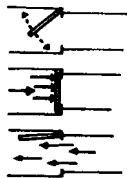

muscle: cords of threads which can become longer or shorter to move parts of the body.



will shut
will open

shut(s)
open(s)

shut
opened

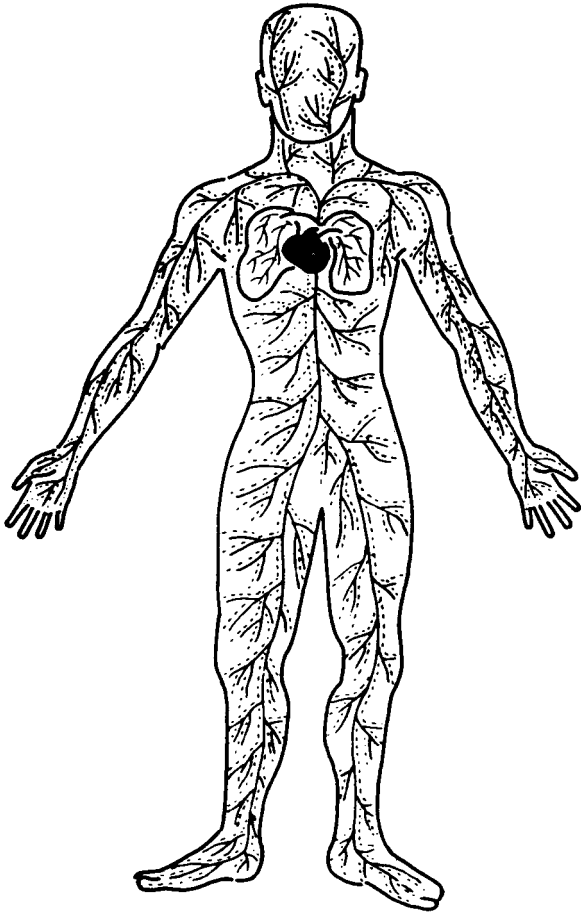

A solid line represents an artery and a broken line a vein.

The first man to discover that the blood goes to all parts of the body, out through the valves of the heart through one system of pipes and back again through another, was the seventeenth-century doctor William Harvey.

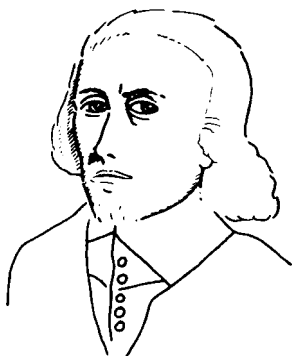

The journey of our blood all round the body is the circulation of the blood. As you see in the picture opposite, the branches of the arteries are like the branches of a tree which get smaller and smaller the farther they are from the roots. The small branches go to all parts of the body. They go to the ends of your fingers and toes, to all the muscles—those parts by which you move your arms and legs and head and other parts of the body.

doctor: man or woman with training which helps them to make and keep people healthy.

circulation: motion round and round.

picture opposite: picture which is on the opposite page.

Everywhere the blood stream does two things: supplies the cells with food and oxygen and takes away waste. It is as if the blood kept the little fires in the cells burning and took away the ashes.

The fuel for the fires in the cells is given us by the food we eat. It cannot burn without oxygen. This gas is as necessary to all living things as it is necessary to the burning of fires made of wood or coal.

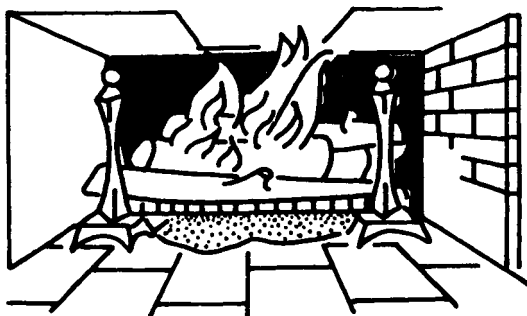

Burning is the change which takes place when oxygen and fuel unite. Coal, wood and other fuels (cooking gas, for example) burn by taking oxygen from the air.

everywhere: in all places, in all parts, at all points.

ash: powder you can see in the place where a wood fire has been burning.

unite: become one new thing, in this sense of unite.

coal: coal is mined from the earth. Trees living millions of years ago have been slowly changed into the hard, black coal in use as fuel.

will unite

unite(s)

united

When you see someone opening a window in a room full of people, you know that is to let in air from outside. As good air comes in through the window, bad, used air, with more carbon dioxide and water in it and less oxygen, goes out.

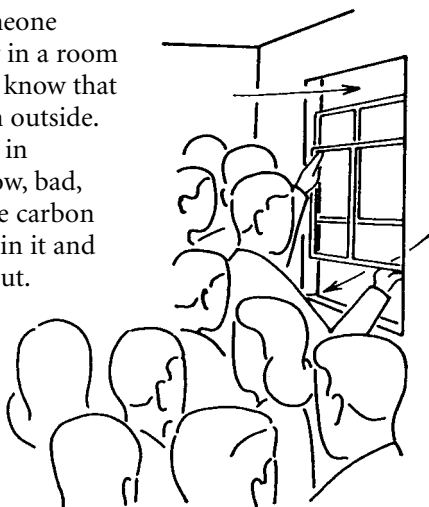

We say good air is fresh air. Fresh air is clean and good to breathe and has enough oxygen in it for our needs.

carbon dioxide: one of the gases present in the air. It is made up of carbon (present in coal) and oxygen united.

fresh: here are some other senses: fresh water is water which is not salt like sea water. Fresh bread is new bread. Fresh paint is paint which has been newly put on.

These boys are outside in the fresh air, breathing deeply while their teacher is saying:

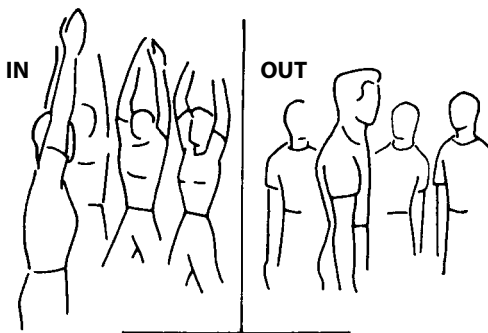

for every breath which they take. If you could watch them you would see their chests becoming first larger, then smaller in size, as their lungs breathed air in and out.

Breathing goes on when we are awake and when we are sleeping. Most of the time we are not conscious of our breathing.

The motion of our lungs as we breathe is automatic. It goes on by itself, the lungs taking fresh air in and letting used air out about eighteen times a minute. This is the common rate of breathing.

We become conscious of our breathing if anything shuts the air off from us, so that we do not get enough oxygen for our needs.

awake: not sleeping.

conscious of: taking note of; feeling; having in mind.

automatic: working by itself, without anyone having to do anything about it consciously.

Keeping your mouth shut, take your nose between your thumb and one finger, so that you shut the air out and shut your breath in. How long can you hold your breath? You will be wise if you do not try to hold it more than a minute. If oxygen is kept from a person for long he will become unconscious.

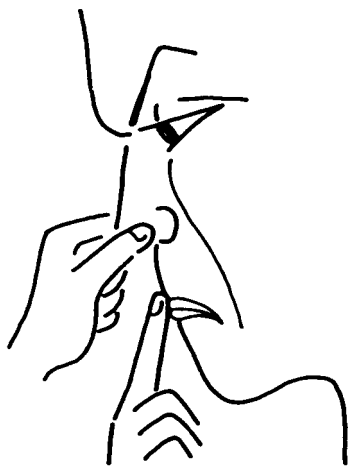

When people become unconscious through getting water or smoke in their lungs it is very important to start them breathing again. This is done by turning them face down (putting something between their teeth to keep their mouths open) and then working their lungs to start them breathing.

hold: keep from changing, keep in one place, keep from moving.

wise: having knowledge and seeing what to do for the best.

unconscious: not conscious, having no sense or feeling or knowledge.

will hold

hold(s)

held

The higher up we go the less is the pressure of the air, because the weight of the air above us is less. As the pressure becomes less (air gets thinner) the amount of oxygen we get in one breath becomes less. We must take in more air to get the same amount of oxygen.

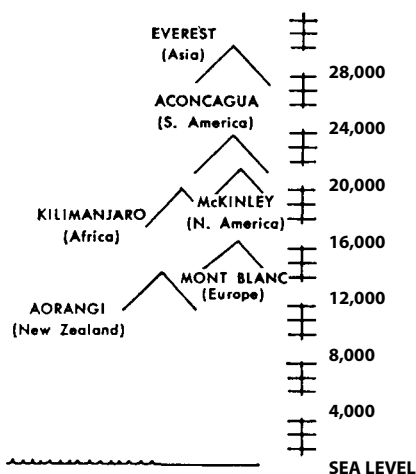

The instrument we use to measure the pressure of the air is the barometer.

the pressure on something: the push on it. The air is pushing on this ball, putting pressure on it, from all sides all the time.



above: over, higher up.

measure: take the measure of.

will measure

measure(s)

measured

Men have been able (1953) to get to the top of the highest mountain in the world, Mount Everest. They had to use oxygen when they got up high. They had to keep control over the amount of oxygen they used. They could get no more supplies from those below.



This man, who is going up a high mountain, is using a supply of oxygen which is stored in those cans he is carrying on his back. By opening and shutting a valve, he controls the amount of oxygen he breathes in. The gas has been pumped into the small space inside the cans. It is under pressure in there and comes out when the valve is opened.

control: power over.

below: lower down, opposite to above.

will control

control(s)

controlled

It was more than a century after Harvey had discovered the circulation of the blood that two other scientists, one English and the other French, discovered oxygen. These men saw that when a flame burns it takes something out of the air. That is why a candle goes out when it has been burning for a little time in a small amount of air. It has taken all the oxygen out of the air. You may see this by putting a lighted candle under a glass cover, so:



When the candle has used up the oxygen from the air it cannot go on burning. It cannot burn without oxygen. Its light goes out.

So with the burning that goes on inside the millions of cells of our bodies. If the blood stops carrying oxygen to the cells, they go out. They die.

so: like this; it is like this.

candles: cotton cord with solid fuel round it. The heat of the flame turns the fuel to liquid and then to gas as it burns. The flame is the burning gas.

stop: do not go on, make a stop, put an end to.

will stop

stop(s)

stopped

When we are running, our hearts are working much harder than when we are sitting down. Our blood is being pumped more quickly through our bodies. The blood must carry a greater supply of oxygen to the muscles all over the body. Our hearts work for us automatically. A heart can pump as much as three thousand gallons of blood a day. The amount pumped at any time is controlled automatically. After running hard we breathe very quickly because while running we couldn't take in enough air for our oxygen needs. We are "out of breath," as we say.

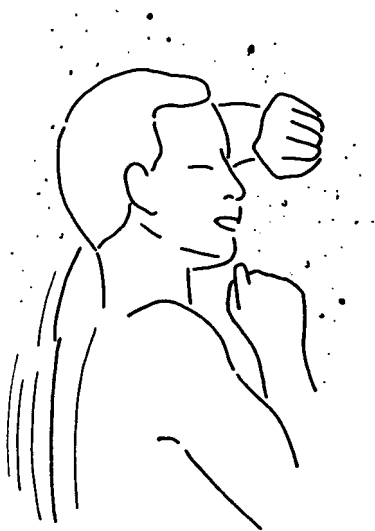

running: going faster on foot than walking.

automatically: in an automatic way.

will run

run(s)

ran, run

Our bodies control themselves in many other ways. For example, the temperature of our bodies (and those of all warm-blooded animals) is controlled; our blood temperature is kept at 98.6 degrees Fahrenheit, or near it.

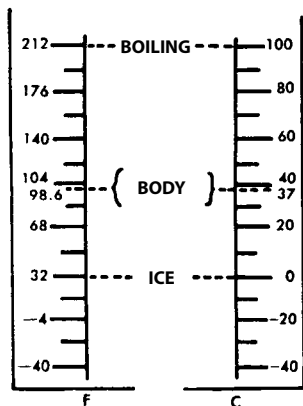

When a person is very ill (sick) some of the automatic controls of the body stop working. The temperature, measured by a Fahrenheit thermometer, may go as high as 103°F or 104°F but if it goes much higher, or keeps as high as that for very long, one cannot go on living, but will die.

temperature: the measure of body heat on a scale.

warm: having a middle degree of temperature not very different from the temperature of our bodies.

degree: temperatures are measured in degrees Fahrenheit (F) or degrees Centigrade (C). We change a temperature from Centigrade to Fahrenheit by the addition of 32 to nine fifths of the number. For example, 100°C is the boiling point of water. This is 100 times 9/5 plus 32 = 180 + 32 = 212°F.

ill: not well, unwell; in some parts of the world the word *sick* is used.

thermometer: instrument for measuring temperature—another of Galileo's inventions. (See page 94.)

If you have a high temperature you will feel unwell. Then it is good to go to bed and send for your doctor.

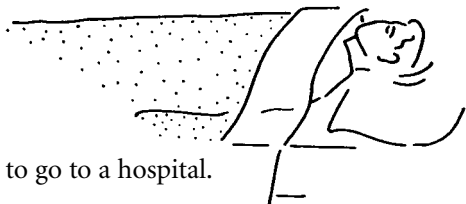

You may have to go to a hospital.

A nurse is taking this patient's temperature. He has had a bad cold and has been in bed for a day. He felt unwell. His temperature went up to 102°F but it is down again.



The nurse is looking at the thermometer, which she put under the man's tongue. He has kept it there with his mouth shut for two minutes.



The man's temperature is 98.6°F . That temperature is right for a healthy person.

hospital: public building where sick people are looked after.

nurse: person trained in looking after people who are ill (sick).

cold: in this sense, the commonest way of being ill.

patient: person who is under the control of a doctor or nurse.



will nurse

nurse(s)

nursed

The body has many different ways of keeping itself warm enough and not too warm. It uses up more food, more fuel for the cells, in cold weather. It shivers—that is, its muscles go on making quick little motions to keep it warm. We cannot stop ourselves from shivering. The body's heating system is not under our conscious control; it is automatic. To stop shivering we have to warm ourselves some other way: we may run or walk quickly, or take hot drinks, or cover ourselves up warmly, or use hot water bottles to warm our beds.



shivering: shaking all over as an effect of cold.

warm: make warm.

hot: very warm, at a high temperature.

heat: make hotter. We warm our hands at a fire, but we heat water on it.

will shiver

will warm

will heat

shiver(s)

warm(s)

heat(s)

shivered

warmed

heated

Our bodies give off some of their heat all the time by sending a little liquid out through the skin. Sometimes the amount gets greater and our skin becomes wet. This cools the body quickly.



Here the man on the left is shivering because he has been waiting in line for a long time in the cold wind. The man on the right is wet all over because he got too hot in the sun. He is drinking water because he feels the need of it. He is thirsty.

cool: make less warm.

too: more than enough.

thirsty: feeling the need to drink.

will cool

cool(s)

cooled

This man is in training. He is going to run a distance of one mile in the shortest possible time. The fastest runners before him have taken a little under four minutes and he wants to make a new record.

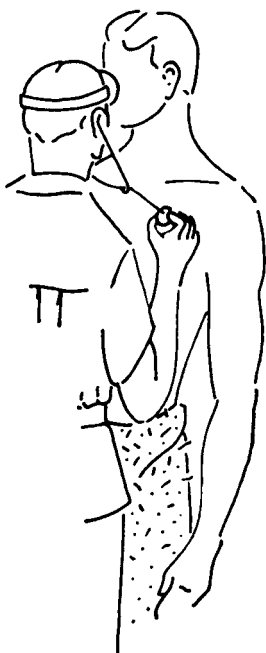

When a man runs a mile in four minutes he is going at a rate of fifteen miles an hour, but it is not possible to keep running at this rate very long.

The runner is standing now in front of his doctor who has an instrument in his hand. Through this the doctor can hear the sounds made by the runner's heart.

possible: able to be done.

under: in this sense, less than.

record: this is another sense of "record." When a person does something better than it has been done before we say he has made a record.

standing: on his feet, not moving.

will stand

stand(s)

stood

Now the doctor is taking the man's pulse. He has his finger on the man's wrist and is counting the times his heart pumps the blood in one minute. The doctor can feel the motion or pulsing of the blood every time the man's heart pumps.

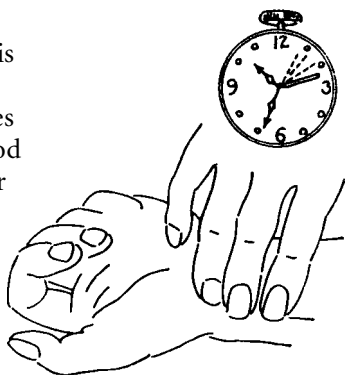

In most people the pulse rate is between seventy and eighty times a minute. In children it is higher.

The runner's pulse rate is 72. It will be higher when he is running.

pulse: motion of the blood through the arteries as it may be felt at points in the body, for example, the wrist.

pulse rate: number of pulses in a minute. (see *EP 2*, pp. 129-131.)

wrist: end of the arm nearest the hand.



counting: using numbers to discover how many.

will count

count(s)

counted

There is a good story about the use of the great Italian scientist Galileo once made of his knowledge of the pulse rate.

Galileo lived three hundred years ago before people had watches for measuring time. In the sixteenth century there were very few clocks in the world and no watches.

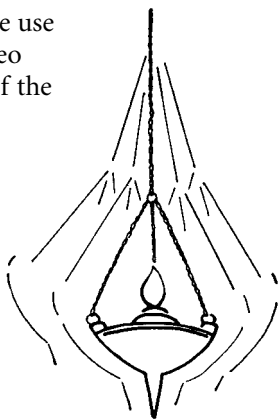

One day when Galileo was a young man of eighteen, he was in the great church of the city of Pisa where he lived. Watching the motion of a light hanging



down on a long chain from the roof high above his head, he saw that as the light moved forward and back on its chain, it seemed to take the same time between turns, however far it went.

once: of one time in the past.

forward: to the front.

chain: support made of metal rings going through one another.



however far: when it went only a short distance and when it went a longer distance.

however: in whatever way.

To see if he was right about the motion of the light, Galileo put his fingers on his wrist. He timed the motion of the light as it went forward and back on its chain, measuring it by his pulse rate.



He was right. He had the proof. He could prove that the time was the same, however short or long the journey of the light through the air was. Galileo had made a great discovery about the motion of a pendulum. Among other things this discovery made possible a better instrument for measuring time—the pendulum clock.

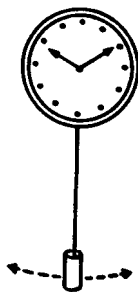

proof: that which makes clear that something is so.

timed: measured the time taken by.

prove: give proof.

pendulum: hanging weight free to move from side to side.

will prove
will time

prove(s)
time(s)

proved
timed

Measuring how fast something is moving gives us the rate of motion.

This plane has gone 300 miles in half an hour. Its rate was 600 m.p.h.



This man has walked two miles in half an hour. He was walking at a rate of four miles an hour. Now he is standing. He is not moving.



This man is working slowly. His pay will be small if he is paid by the amount of work he does in a day.



This other man is working quickly. His pay will be high if he is paid by the amount of work done in a day.

The two commonest ways of paying a worker are by the hour and by the amount of work done. Piecework is work paid by the amount done. For different sorts of work rates of pay may be different. Sometimes rates for the same sort of work are different in different places.

piece: bit, amount, part of something solid.

m.p.h.: miles per hour, miles in an hour, measure of rate of motion (*EP* 2, 129).

pay: amount of money given for work.

will pay

pay(s)

paid

In different countries different sorts of money may be used. In the U.S.A. and Canada people are paid in dollars; in the U.K. they are paid in pounds.

The rate of exchange between the U.S.A. dollar and the pound in 2004 was about \$1.76 to £1. You could exchange a pound for \$1.76.

Here are some other rates of exchange; they are for the business week August 16–August 20, 2004:

Canada.....	\$ 1.30	U.S.A.	\$1.00
India (Rupees).....	R 46.28	U.S.A.	1.00
Italy (Euro).....	€ 0.8293	U.S.A.	1.00

A table of exchange rates is printed in the newspaper.

exchange: amount of one sort of money paid for an amount of another.

table: in this sense, list of relations between numbers.

print: mark made by pressure; printing of books began in Europe in 1438.

The first newspapers were printed in the late seventeenth century.

will print

print(s)

printed

When we move about from one country to another we sometimes have to change our money, we sometimes have to change our watches and sometimes we change both. When we change our watches we move the hands forward or back: forward if we are going east and back if we are going west.

Here is a map giving time lines across the Pacific Ocean.

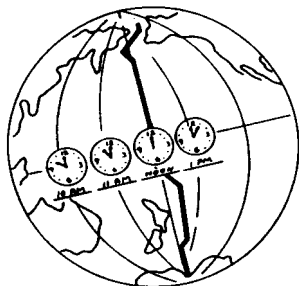

In the days when Galileo used his pulse as a timekeeper, most people did not even know that the earth was round. They knew no more about the journey of the earth around the sun than they did about the journey of their blood stream through their bodies.

both: the two, one and the other of two.

even: so much as. *Even* gives the idea that something is much more than we would think—or much less.

But, two thousand years before Galileo, there were Egyptians and Greeks who knew more than a little about the motions of the sun and stars and the angles between them at different times. Some few Greeks even knew that the earth is not flat, as it seems, but round like a ball. One of them even said that it was about 25,000 miles round, which it is, and that the earth moved round the sun while turning on itself.

It is from the Greek language (sometimes through Latin and French) that many of the words used in science have come. For example:

graph from *graphein*, write.

photograph fr. *phos*, *photos*, light, and *graphein*.

energy fr. *energeia*, *en*, in, *ergon*, work.

telescope fr. *tele*, far, and *scopos*, a watcher.

telephone fr. *tele* and *phone*, voice.

microscope fr. *micros*, small, and *scopos*.

thermometer fr. *therme*, heat and *metron*, measure.

flat: like a floor, with no part higher than another. Some lands are flat; others are all mountains and others again have both high and low land.

even said: went so far as to say.

But for another two thousand years most people went on thinking that the earth was flat like a large plate with the sun and stars journeying round it.

How was the idea that the earth is not flat but round like a ball proved true in the end?

Sailing men went out in their ships to find a way by water from Europe to India and China. Though some ships from the north of Europe had sailed west to parts of America in the tenth century, most of Europe had no knowledge of the land across the Atlantic.

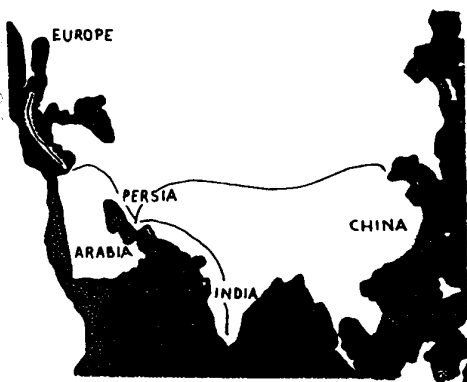

Men like Marco Polo had gone east to India and China, much of the way by land, long before Columbus, in 1492, went sailing west with the idea that he could get round to the Far East by water.

to find: to look for and discover or come upon.

though: even if.

will find

find(s)

found

Christopher Columbus has gone down in history as the man who discovered America. He was looking for a way of getting to the East by sailing west. It was hard for him to get help for this journey. He was laughed at by most people when he said he could go this way to India because the earth was round.

This is the sort of ship Columbus sailed in.

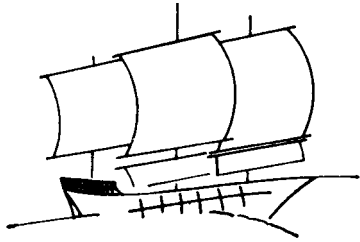

He made use of a half-hour sand glass for measuring time at sea. Through all the long months the glasses on Columbus's three ships had to be turned every half-hour as the sand ran out.

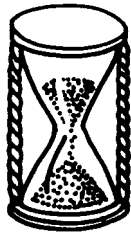

gone down: been given a place. When a person's name goes down in history something he has done is recorded in history books.

could: in this sense, would be able to—as used on the opposite page.

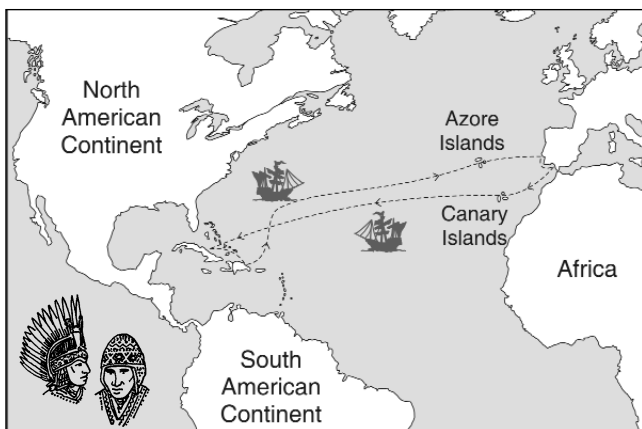

People living in America were named Indians by Columbus because he thought he had got to India when he discovered America. He went back to Spain without knowing that he had found a new continent. He knew nothing of the life that had been going on in North and South America for thousands of years or of the two great peoples, the Aztecs and the Incas, who had been living there—the one in Mexico, the other in Peru—for centuries. It is now thought that in 1500 the population of the Americas was about 30 million, and that the first of these “Indians” had come from Asia themselves. There may have been a land bridge between Asia and Alaska across which they could have come.

continent: Europe, Asia, Africa, North America, South America, Australia and Antarctica are the continents of the world.

it is now thought: scientists now think.

Thirty years after Columbus discovered America, the ship of Magellan, a sailor of Portugal, was the first to make its way south of South America and on round the world through the Indian Ocean and past the Cape of Good Hope back to Europe.

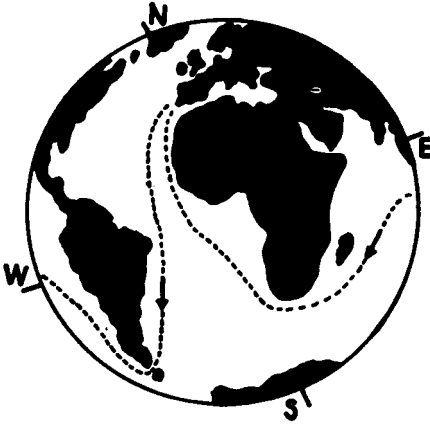

Magellan himself died on one of the Philippine Islands on April 27 (in) 1521.

When a ship sailed out to the west and came back home from the east three years later people could see that the earth must be round. This proved that the earth was round. It was proof enough for most people.

sailor: man who works on ships at sea.

cape: piece of land pointing out into the water.

hope: see page 185.

But it was harder to take in the idea that the earth might be moving round the sun, as Copernicus of Poland, 1473–1543, said it was. Very few people had made any sense of the writings of Copernicus by the time he died in 1543, twenty-one years before Galileo and Shakespeare were born. Few people could read or write in those days.

It was Galileo who made the first telescope, through which he could watch the stars and look into the ideas that Copernicus and others had been working upon. Through his telescope the stars seemed more than thirty times as near, and he could see not only the mountains of the moon but spots on the face of the sun, and the motion of the moons moving round the planet Jupiter.

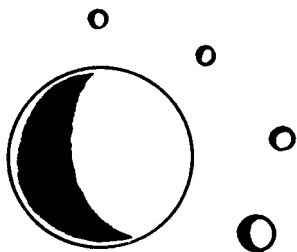

very few: opposite of very many.

spot: small mark.

Jupiter: Jupiter is the name of one of the planets—great bodies which are moving round the sun as the earth is.

Galileo could let people look through his telescope but he could not make most of them see the picture of the universe that was becoming clear in his mind.

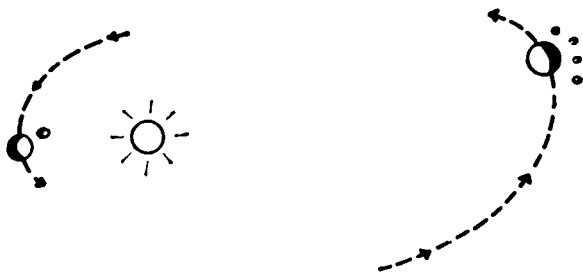

He could not do that any more than Copernicus had been able to do it. People's ideas were changing, but not as quickly as his.

Galileo was put in prison for saying that the ideas written down by Ptolemy fifteen hundred years before did not make sense to him.

universe: everything there is.

prison: place where wrongdoers or those said to have done wrong are locked up.

Newton, who was born the year that Galileo died (1642), took the new line of thought much farther.

Like Galileo he became a great watcher and recorder, asking the question “how,” more than “why” and answering by measuring and recording and comparing and proving.



Even more than Galileo, he saw the universe as part of a great machine, and he was able to put into words great natural laws—accounts of its workings.

comparing: finding where and how things are the same or different.

law: laws which are made by people are statements, backed by government power, controlling what one may or may not do. When some laws are broken, the person who breaks them, if it is proved that he did so, may be put in prison.

natural: laws not made by people.

natural law: statement of causes and effects at work everywhere.

will compare
will break

compare(s)
break(s)

compared
broke, broken

He was able to do this only because he was carried forward on the shoulders of such men as Galileo, Kepler and Copernicus. With their work before him he could think out new ideas about the weights of things and their motions. His Law of Gravitation says that all things in the universe have an attraction for one another. (See *EP 2*, pp. 78–97.)

It was only by standing on Newton's and other scientists' shoulders that Einstein (1879–1955) was able to get his picture of the universe and work out new ideas about time and space and energy.

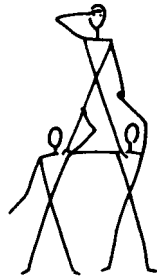

Their work made it possible for him to see farther into the laws of the universe than they could. Younger scientists in their turn are developing new ideas made possible by Einstein.

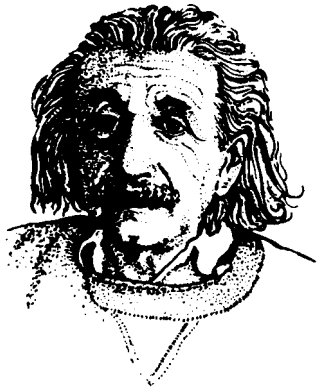

about: in this sense, *of*.

shoulder: part of body between arm, neck and chest.

The thinking of scientists has become clearer and truer as their instruments have become better. Galileo made one of the first microscopes as well as the first telescope, and by the middle of the seventeenth century this new instrument had opened up another world, a world of things too small for our eyes by themselves to see.

The microscope made possible the discovery of the cell structure of all living things.

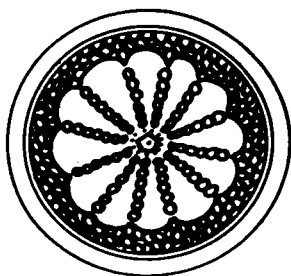

**The same seen through
a microscope**

Even the human body could be pictured now as a great machine with millions upon millions of working parts, each part a cell.

structure: how a thing is made up; the way its parts are put together. The structure of the plant stem in the picture above, right, is made clearer by the microscope.

human: like a man or woman, different from animals.

Together with all this new knowledge of the cell structure of plants and animals, the microscope opened up a world of living beings so small that people had no idea such things were possible.

It was a surprise to the scientist to see that in a drop of water there might be thousands of living things of many different sorts moving about and taking in food.



With the invention of such instruments as the microscope and telescope, people found themselves walking between two strange new worlds: one too far off and great, the other too near and small for anyone but the scientist to know much about or do much about. As science developed, thinking people came to feel less and less at home in the universe. They had enough knowledge to become conscious of the need for more.

such: like these.

such things: things like these.

surprise: a feeling we have when we see something strange.

Our bodies can be looked upon as machines which are kept going by fuel. As food is burned up in the body cells it gives us heat and other sorts of energy. All through our lives—from birth to death—we must be supplied with energy.

Even when we are sleeping we are using up some food to keep our bodies warm. Our lungs and heart keep on working. Some animals sleep through the cold winter weather: snakes, for example. When they are asleep their rate of breathing and pulse rate and temperature go down, and less food is needed.

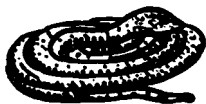

Only animals that can store enough fat in their bodies to keep them alive through the winter can sleep through the months when food is hard to get.

life: time of living.

death: end of living.

snake: a long narrow-bodied animal with no legs. Some sorts of snakes have poison in their long, needle sharp front teeth. If this poison gets into your blood stream it can cause death in a few minutes.

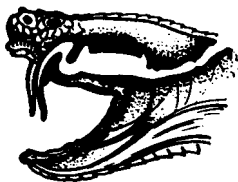

asleep: sleeping; opposite of **awake**.

will sleep

sleep(s)

slept

While our bodies are at rest the large muscles are not in use. It is these large muscles which pull on our bones and let us move as we want to.

Hard work with our large muscles uses up energy quickly so that we come to feel hungry and want to eat.

The more we know about the parts of our bodies and their work, the more new questions come to our minds, questions such as:

How is it possible for all the different parts of us to grow from one cell?

How is it possible for all the millions of cells in our growing bodies to go on doing what they do without our being conscious of their workings?



while: through the time that; in the time when.

hungry: feeling need and desire for food.

will pull

pull(s)

pulled

Through about two billion (2,000,000,000) years, scientists say, the development of plants and animals on our earth has been going on. At first both were very small, much less than a pin point in size. We might say that the first plants or animals were bodies living in one-roomed houses, too small for the eye to see. All the housekeeping went on in one room. Such cells take food in and let waste out. They do not give birth to new cells but divide to become two daughter cells.

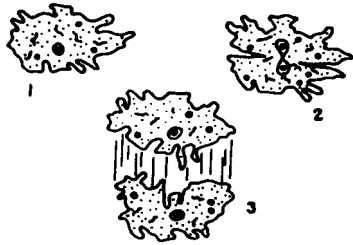

These three pictures show the division of a cell into two separate cells, each of which may in turn divide into two more.

much less: a great amount less.

show: make clear, let be seen.

division: becoming two (or more) in place of one.

separate: not together.

divide: make a division; become two or more.

will divide

will show

divide(s)

shows(s)

divided

showed, shown

The earth itself is thought to be more than twice as old as life on it. Our picture of what it was like two billion (2,000,000,000) years ago is of a great ball about as hot on its surface as boiling water.

In time, as the earth's surface became less hot, the thick clouds round it, from which water went on raining down, got thinner. Then more sunlight could get through to the surface of the earth. Sunlight is necessary for life on earth, as air and water are.

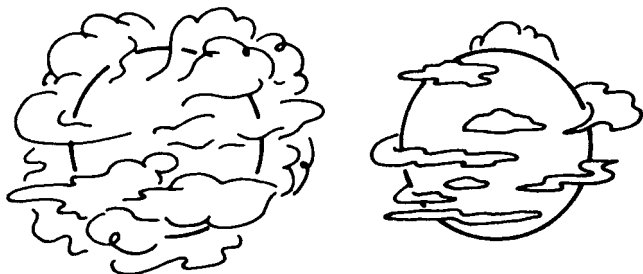

life: in this sense, that which only living things have.

surface: outside part. This page has two large opposite surfaces: one this side (page 113) and the other (page 114) which you will see when you turn over.

Life began, people think, in the salt sea. Near the land, where the waters were not deep, very small one-celled organisms came into being.

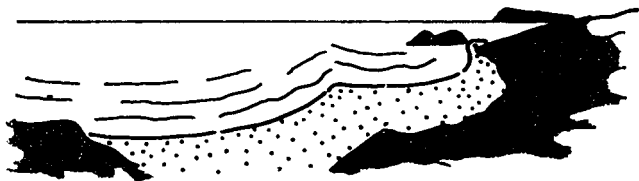

The cells in our bodies are of many different sorts but they all have water in them. Our bodies are seventy per cent water.

This water has in it about the same amount of salt, common table salt, as there was in the water of the sea in which the earliest organisms swam. That water was a little less salt than sea water is today. In billions of years the rivers have washed down more and more salt from the land into the sea. The sea has become more salt. The water in our bodies does not become more salt. Even if we eat a great amount of salt in our food the body automatically controls how much it will keep in the blood stream. And the same is true if we let very much salt out through the skin when we get overheated. (See page 91.) Then we have to eat something that will give us new supplies of salt.

organism: living body.

per cent: in a hundred. Seventy per cent (70%), seventy parts in a hundred.
(Latin, *per centum*.)

The first living things, though they were too small to be seen, were eating, growing organisms which divided to become others like them.

Under a microscope, a cell looks like a bit of clear jelly with a thin wall round it. Very small openings in the walls of the cell let food in and waste out. In every cell

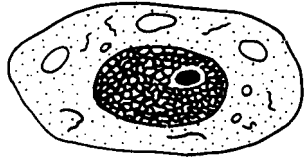

there is a part like a little ball. This is the nucleus, which organizes the work of the cell. Though cells were discovered two and a half centuries ago, it is only in the last hundred years that knowledge of the work of the nucleus has developed. It is this nucleus which keeps the cell working at what has to be done. It is to the cell what London is to Britain, New Delhi to India, Beijing to China. It is the seat of government.

jelly: a soft material, not solid and not liquid.

nucleus: see above on this page.

organize: give every part its work to do and control it.

will organize

organize(s)

organized

All living things are developments from these one-celled organisms. They have developed step by step through change upon change from these first, simple, living things. Our bodies and the bodies of the plants and animals we see about us are highly complex in their structure. They have in them millions of millions of cells, some doing one sort of work, some another. Every different cell has its own sort of work to do.

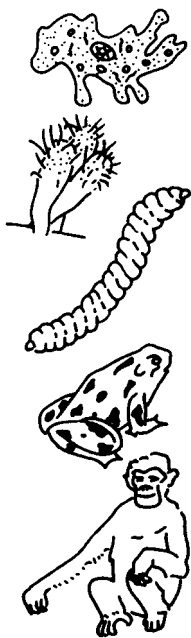

What do the words *simple* and *complex* mean?

simple: not complex.

complex: not simple (see next page).

The greater the number of parts a thing has, the more complex it is.

The smaller the number of parts a thing has, the simpler it is.

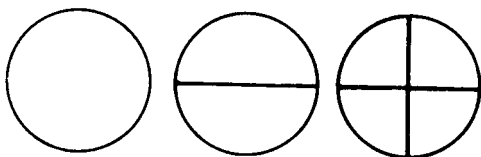

Which of these is the more complex?

The more different the parts of a thing are from one another, the more complex it is.

The less different the parts of a thing are from one another, the less complex it is.

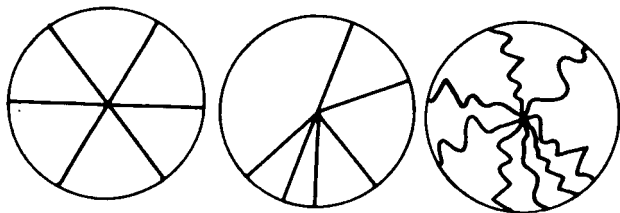

Which of these is more complex?

The more the parts of a thing need one another, the more complex it is.

Take one little wheel out of a watch, for example, and see if the other parts can do their work without it.

Which is more complex—a stone or a plant?



The leaves, the flower, stem and roots of the plant work together to keep it alive. But each does a different sort of work and each is dependent upon all the others. The work of each part is different.

The parts of a stone do not work in this way for one another. A stone is a much simpler thing than a plant.

Any living thing, however small or simple it may seem, is far more complex than anything which has no life.

People are the most complex of all organisms, far more complex than any plant. We would not go on living, but would die, if the millions of millions of cells in our bodies did

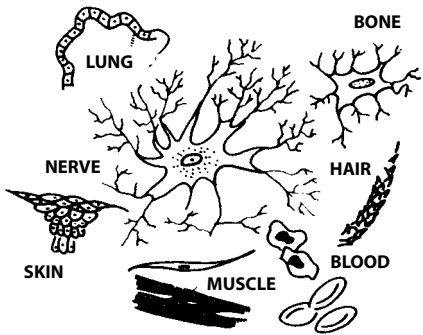

not work together in their different ways, each doing its own sort of work. The cells are dependent upon one another and we are dependent upon our cells.

The picture below shows what the word *dependent* can mean.

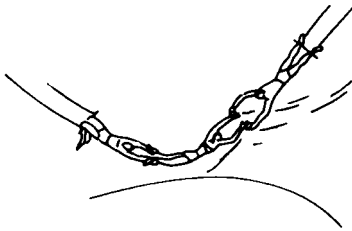

The girl in the middle is dependent on both men to keep her from falling. The man who has been holding her feet is letting go as the other man takes hold of her hands. She has been dependent on the first man. She will be dependent on the second. Their act depends on timing.

their act: what they do. A man's acts are what he does.

depends: is dependent on.

letting go: letting them go.

will depend

depend(s)

depended

There are about five million red cells in one cubic millimeter of our blood. One millimeter is a thousandth part of a meter and a tenth of a centimeter.

One cubic centimeter—how much space does that take up?

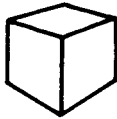

Here is a picture of a cube which is one centimeter long, one centimeter wide and one centimeter high. It takes up one cubic centimeter of space. A centimeter is a little less than half an inch.

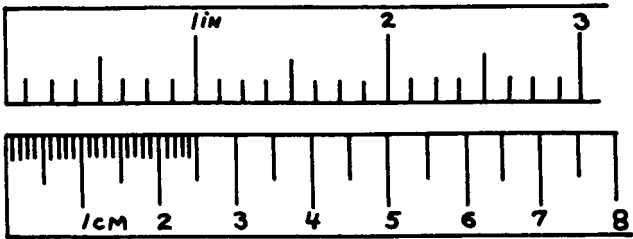

millimeter: mm = .001 of a meter.

centimeter: cm = .01 of a meter, or .3937 of an inch.

cube: a solid the six sides of which are equal squares.

square: a square has four sides which are equal and four angles which are right angles (*EP 2*, p. 35).

You can put a paper cube this size together for yourself, or cut one out of soap or cheese.

To make a paper cube, take a pencil and make six one centimeter squares like this:

Now take your scissors and cut round the outer lines. Do not cut the broken lines but make folds there. Put the edges together to make a hollow paper cube, as in the picture. Your cube will be a cubic centimeter in size.

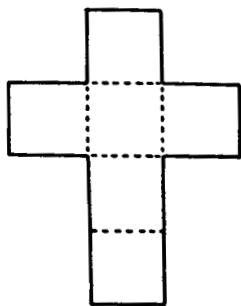

A cube has six sides; its sides are equal squares. The surface of a one-centimeter cube is six square centimeters. In one cubic centimeter of our blood there are about five billion red cells.



fold: this is a page folded down.



edge: this is the edge of the page.

Living things are made up of cells, and cells do not grow to be more than twice the size they were at first.



But trees can grow to be many thousands of times the size they were as seeds. The tallest tree known is 364 feet high. One great tree in California is as much as 115 feet round its trunk at the thickest point.

How does such growth take place if cells do not grow to be more than twice as large as they were at first?

It all takes place through division. The cells which make up the organism are able to divide into two and this division goes on and on. When you were born you had as many as 200 billion cells in your body all coming, in nine months, from the division of one cell $\frac{1}{175}$ th of an inch across.

trunk: stem of a tree.

growth: growing, becoming greater in number or size, the outcome of growing.

All organisms which you see in the world about you have grown by cell division.

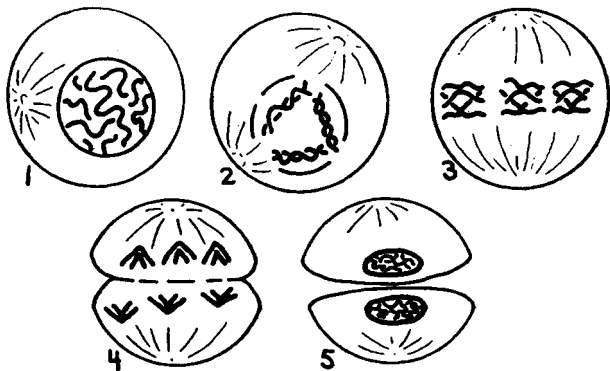

You and I have become what we are through billions of divisions in the cells whose outcome is our cell structure at this minute.

In cell division the two halves of the cell (as you see in picture four) become ready to separate. In picture five you see that they have separated. The cell in picture one, by division, has become two separate cells. The daughter cells do in every way the same as their mother cell did. One of the greatest questions scientists are working on is: What keeps the daughter cells doing what they have to do?

separate: become or make separate.

will separate

separate(s)

separated

Even the simplest living organism is far more complex than any machines that people have made. Organisms are built up of parts which are themselves more complex than any machine. And these parts in turn are the most complex things the science of chemistry knows. It is because they are so complex that they can work together in an organism in so many different ways.

Chemistry is about the different ways in which different materials are built up. For example:

Water is made up of oxygen and hydrogen united in a way which may be represented like this.



Carbon dioxide is made up of carbon and oxygen in a way which may be represented like this.

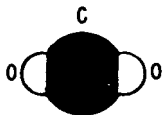

Chemists make use of the formula H_2O for water in their writing. They use formulas to represent the structure of all material things.

formula: chemists' way of representing structures.

The most important of the materials in our bodies are the proteins (from Greek *proteios*, meaning “having first place”). Among them are materials with the most complex structures known to the chemist. We can get some idea of how complex proteins are by comparing the formula for one of them with the formula for water (H_2O) or for carbon dioxide (CO_2).

Compare this formula for a protein from milk:



with the simple formulas for water:



or carbon dioxide:



The letter N in this formula represents nitrogen and the letter S represents sulphur.

among: in, in the sense of being part of a group.

nitrogen: a gas which makes up about four fifths of air. Nitrogen is breathed in and out unchanged. Our bodies have to get the nitrogen they need in other ways.

sulphur: a light-yellow material found in some parts of the earth in great amounts.

There may be as many as 100,000 different sorts of proteins in the human body, at work in as many different ways.

It is a protein in our blood which takes up oxygen from the air we breathe into our lungs and carries it to the cells which need it. It is another protein which makes our bones strong, and another which makes our muscles able to pull on and move our bones. It is other proteins in our hair and skin and nails which make them what they are.



Others again do very important work in the digestion of food, in controlling other changes in the body, in keeping it healthy and in making children become so surprisingly like their parents.

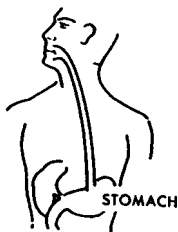

nail: finger nail, toe nail. Our nails are living parts of us.

digestion: the changing of food in the mouth and stomach so that materials in the food may be used by the body.

How do these very complex materials come into being? The answer is, through the work of plants.

Plants need sunlight. This is common knowledge within the experience of most of us, but you can show how true it is if you make this little experiment.

Grow two bean seeds over glasses of water, starting them in a dark cupboard. After a few days take one glass out into the daylight and keep the other in the dark. Compare the two from time to time. You will find that it is the plant in the light which grows a strong stem and green leaves.



within: in; inside. Not an opposite of without as commonly used (see page 32).

experience: knowledge we get as we go on living, seeing what goes on, and thinking about it.

experiment: getting knowledge by doing something so that you are able to watch what takes place and find what in the outcome is dependent upon what.

bean: common plant whose seeds, and sometimes seed coverings, are used for food.

In 1772 the Englishman Joseph Priestley, the discoverer of oxygen, made a most important experiment. He knew from experience that air is necessary to plants and animals. He knew that if you put a live mouse, for example, under a glass so that no fresh air can come to it, the mouse in a short time will die. It will have taken all the oxygen out of the air and without oxygen it cannot go on living.

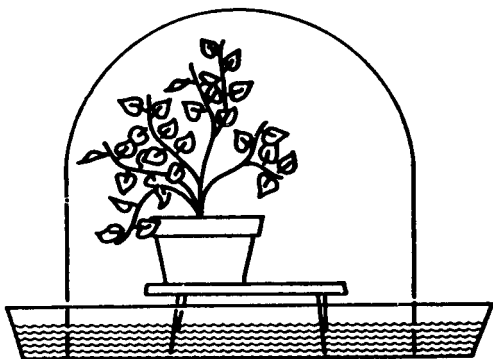

Priestley put a green plant under a large glass cover standing in water so that no fresh air could get in. He thought that in a little while he would find the plant dead like the mouse.

live: alive, living.

mouse: small dark-brown or gray animal with a long tail.

while: in this sense, a space of time.

But no. Here is what he said:

“When it had gone on growing there for some months, I found that the air would neither put out a candle nor was it bad for a mouse which I put into it.”

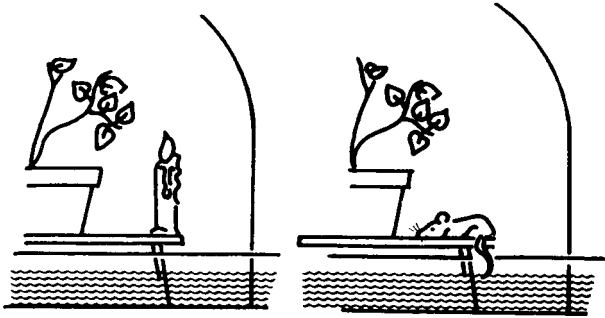

In other words, the green plant had not used up all the oxygen in the air.

The next step was taken when a Dutch scientist found that Priestley's experiment would not work without light. In the light a plant gives out oxygen and builds up sugars and other complex materials in itself. In the dark (without light) it gives out carbon dioxide and water.

had gone on growing: had been growing; had grown. We go on growing until we have grown up and are grownups.

either, or: one or the other of two.

neither, nor: not one and not the other of two.

The material which makes plants green (chlorophyll) is necessary if they are to use energy from light for healthy growth. Unlike animals, plants can take what they need straight from the air and earth and water in which they live. Through their green leaves and stems they separate H from H_2O and unite it with CO_2 to make carbohydrates.

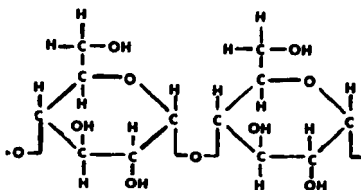

Structure of part of a carbohydrate, a sugar.

This power of plants is named photosynthesis (from the Greek words for *light* and *putting together*). People and animals depend upon photosynthesis in plants to supply their food and energy. We and the animals either eat plants or eat plant-eating animals or both.

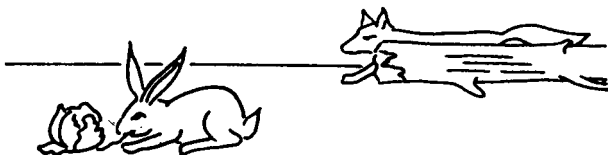

carbohydrate: any of a number of materials made by green plants from carbon, hydrogen and oxygen and used for growth or stored for future use.

When we think it out we can see that most of the energy we use comes from the sun by way of the materials which plants build up in photosynthesis.

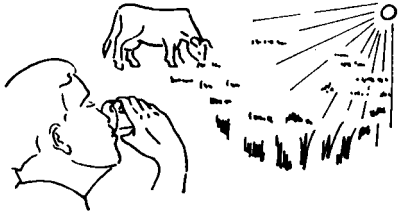

Scientists know only a little, so far, about photosynthesis. It is only a little more than a hundred years since the first account of it was given by the German scientist von Mayer. But with more experimenting being done every year, much more will certainly be known before very long.

The rate at which scientific knowledge is increasing is going up all the time.

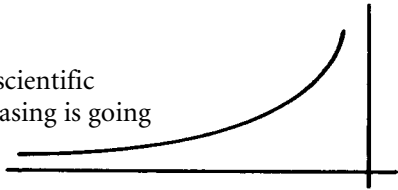

In time (but we may have to wait a long time before this) it may even be possible to use the energy of light itself in industry to do in our factories something like what plants do in their green cells.

since: from the time when.

industry: making things on a large scale: the automobile industry, ship-building industry, clothing industry, for example.

scientific: of, to do with, used in science.

wait: be waiting.

will wait

wait(s)

waited

Before long, we may learn from working on photosynthesis how to make or grow more food. As we have seen (page 13 above) more than one billion people on this planet are short of food. As more and more people are born, the need for new food supplies will increase. It may be that we can find what we want in the sea. It is thought that as much as 90 per cent of the photosynthesis which takes place in the world goes on in microscopic water plants in the sea. Maybe much of the food people are going to need in the future will come out of the oceans.

Or making food straight from complexes of carbon, hydrogen and oxygen may become a great new industry.

At present we have to get most of the energy used in industry by burning coal and oil and other fuels.

microscopic: so small that we have to use a microscope to see them.

maybe: it may be that ... possibly.

oil: the oils are a large group of liquids of many sorts. Some we got from plants (the olive tree, for example), some from animals (fish oils), some from deep down in the earth. Oils are lighter than water, burn easily and have many uses. One of their chief uses is as fuel for gasoline engines. Gasoline (or petroleum) is "gas" in the U.S.A. but "petrol" in Britain.

This energy is the sun's energy stored up long ago by plants. Coal comes from the dead bodies of plants stored, away from the air and under pressure, through millions of years in great beds in the earth. The amount of coal and oil in the earth is, it is true, very great, but the amount we are using today is great too. A time may come before long when we will have used up all the coal and oil that is easy to get at.

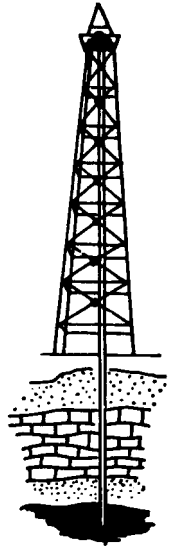

We have been taking oil out of the earth only since about 1860. Without oil there would be no cars and no airplanes. It is strange to think that airplanes depend on what plants were doing millions of years ago.

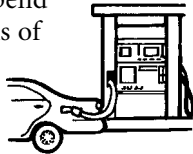

Plants and animals all need air. Only about one fifth ($\frac{1}{5}$) of the air is oxygen. The other four fifths is another gas, without taste, smell or color, named nitrogen. Both plants and animals need nitrogen as well as oxygen but they cannot take it from the air themselves. How do they get their supply of nitrogen?



There are very small organisms in soil and water which can take nitrogen out of the air and fix it in complex materials which plants and animals can use. These materials are taken up by plants through their roots in water from the soil. Animals get their nitrogen by eating plants. Some of this nitrogen comes away in animal waste and people have for many thousands of years known enough to put animal waste back into the soil to help plants grow.

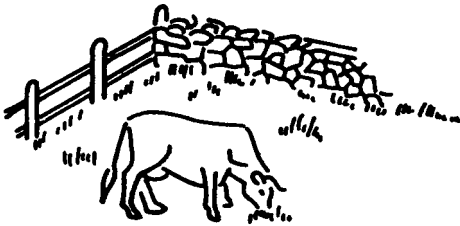

soil: earth in which plants can grow.

fix: make fixed; keep something from changing.

will fix

fix(es)

fixed

Nitrogen, like carbon, oxygen and hydrogen, is used over and over again in support of life. Plants build nitrogen up into complex structures. Animals eat the plants. Then animal waste and dead plants and fallen leaves are broken down into simpler forms again.

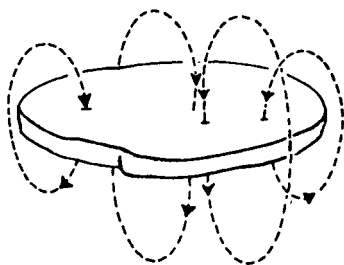

So the great round goes on without end, all made possible only by energy coming from the sun.

Scientists say that all the oxygen and all the carbon dioxide now in the air have been put there after use by plants through photosynthesis.

fallen: fallen leaves are leaves which fell from trees (see *EP 2*, p. 57). The fall of the leaves takes place in the fall of the year when they fall from the branches.

will fall

fall(s)

fell, fallen

All organisms, it is clear, have a number of needs in common, of which air, water, food and the sun's light and heat are the chief.

But people have many other needs, though we may not think of them as needs. One of them, our need for other people, is very important. First of all, we need other people to do things for us when we are very young or very old, or when we are ill.

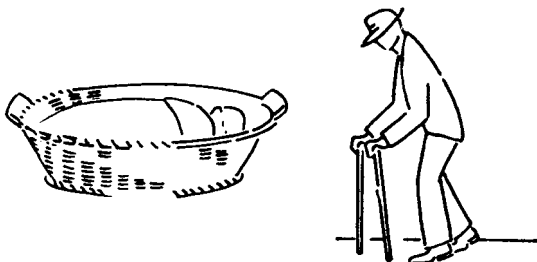

We need others to take care of us. We need their help. We need them to do things for us which we cannot do for ourselves. We need their love.

care: when people look after us, do things for us which we need to have done, they take care of us, they help us.

love: warm feeling for. Desire to take care of a person is one sort of love. There are many sorts of love (see *EP 2*, p. 19).

Every hour of our lives we do things that are possible only because of work which is done for us by other people.



Who grew the cotton? Who made the sheets? Who watched the sheep? Who washed the wool? Who made the blankets for the bed you sleep in?

Whose work are you using when you turn on the light?

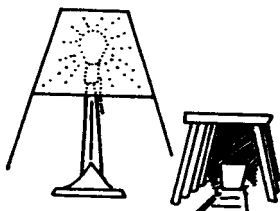

Who mined the coal which gives the power to heat and light your room?

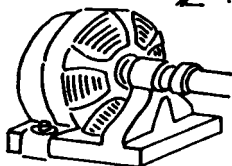

But equally men and women need to do things for other people. Most people are not happy if they are not in some way helping others—doing things for others. They need someone to love.

sheet: cotton cover used on bed for sleeping on or under.

blanket: warm wool bed cover.

will wash
will mine
will light
will love

wash(es)
mine(s)
light(s)
love(s)

washed
mined
lighted
loved

All our lives we need other people.

In many parts of the world families do everything for themselves.

Until the nineteenth century this was true almost everywhere outside the cities. Families were self-supporting.

They grew the food they needed,



built their own houses, and

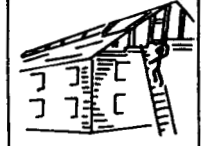

made their own clothing and furniture,



the candles for lighting the rooms at night,

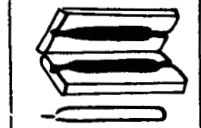

and the plows and carts for work on the farm by day...



In every way they took care of themselves. Living like this, a family is very like a simple organism.

But a family living in a city today is more like a cell in a complex organism. Other people whom it does not know do almost everything for it. Workers in factories make the things it needs and send them to the stores, which sell them to it.

Other people teach its children in schools and take care of them in hospitals when they are ill. Police and fire stations keep watch over the city. Lighting and water supplies, the clearing away of waste, the upkeep of streets and roads are all public services.



In exchange for all this, each of us does our own sort of work, our daily round, whatever it is. This is true for most of us, if not all.

police: men and women whose work it is to see that laws are kept.

upkeep: keeping so that they may be used.

public: done for the good of all.

service: work done for others.

daily: day after day; every day.

People need play as well as work, though, if your interest is deep enough, work and play can be the same thing. To some people all their best work is a sort of play. They get so much pleasure from it and are so interested in it that they work when they don't need to. They are doing what they want most to do.

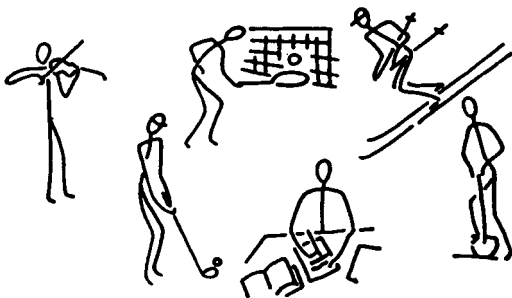

It was the philosopher Plato who said, “All learning is best done as play. Nothing learned under pressure takes root rightly in the mind. So let children’s work be a sort of play.” (*Republic*, 537.)

interest: attraction of the mind to something, pleasure in knowledge of something or in doing something. (See *EP 2*, p. 148.)

philosopher: thinker, lover of knowledge (from two Greek words *philos*, loving; *sophos*, wise). One who is interested in all things.

People need work and play for the body and for the mind.

They need music ...



and dancing. ...



... rest and change.
(See *EP 1*, p. 266.)

They need books and talk with others: with old friends as well as with new people. They need new knowledge to keep their old knowledge clear and living.



A friend is someone you know and love and with whom you have much in common. People you know only a little are not your friends in this sense, though they may become your friends if you get to know them better.

dancing: moving in time to music.

will dance

dance(s)

danced

People need to see beautiful things and to have beautiful things about them.

Drawing goes back very far into our past. The drawings of animals copied on this page may have been made as early as 25,000 B.C.

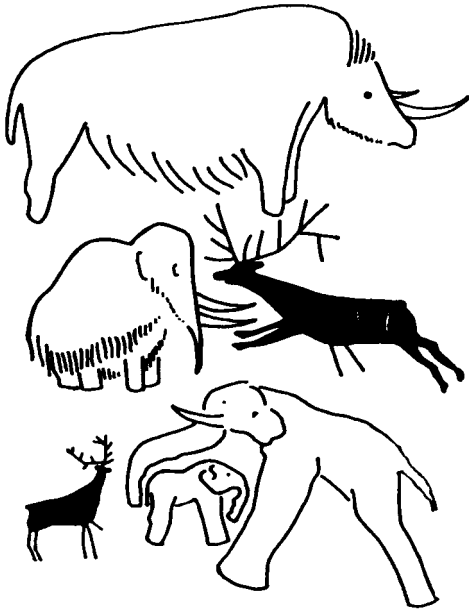

drawing: making pictures with lines.

copied: a copy of something is another thing made as much like it as possible.

will draw
will copy

draw(s)
copy(ies)

drew, drawn
copied

Drawing can help to make ideas easier—the pictures drawn in this book, for example.

But the greatest drawing and painting and sculpture can make our highest powers come into play. The drawings below are of two pieces of sculpture, one from India and the other from Africa.



sculpture: making beautiful things from stone, wood, metal or other materials; the works so made.

We need to hear beautiful things.

Music may go back still farther in time than the other arts, but unhappily we have no records of music before the discovery of writing. As with language the writing of music may have started with pictures.



Today not only do we have ways of writing down music, but we can make copies of the sound of music as it is played.

art: work done to feed the mind and heart through the senses and feelings: painting, sculpture, music, etc.

We need to make beautiful things.

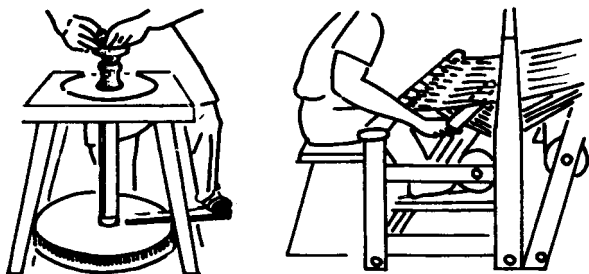

Today the great cities of the world have public art galleries and museums where anyone may see the paintings and drawings and sculpture of artists through the centuries.

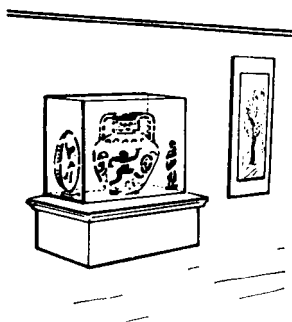

artist: worker at one of the arts.

art gallery: building where works of art are kept for people to look at.

museum: building where important works of art, science, history, etc., are housed.

Great cities have theaters where plays of the past and the present are acted. They have music buildings where great works of music are played. They have libraries where the best that has been thought and written can be found.

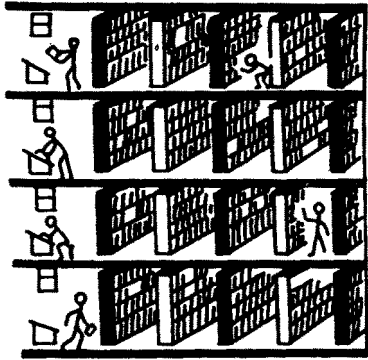

Art and music and poetry come out of our greatest hours with ourselves, and give others some of their greatest hours.

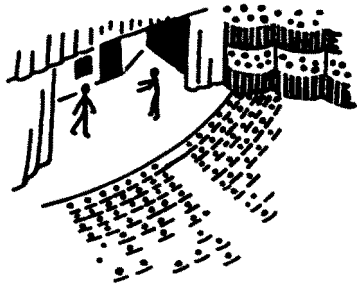

theater: building where plays are given.

acted: when a play is given, it is acted by actors (players).

library: building or room for keeping books; the books kept there.

poetry: words put together in the best way so that others can see and feel what they mean.

will act

act(s)

acted

We need to be alone sometimes to get to know ourselves better, though we need to be with other people too, to get to know them better and ourselves through them.

The more we know one another, the better able we will be to live together in the world. The nations on the earth—the Chinese, the Indians, the British, the Russians, the Germans, the Americans, the French and the others—know very little about one another. They look in different directions and have different ideas of themselves and of the world. They live in different worlds.

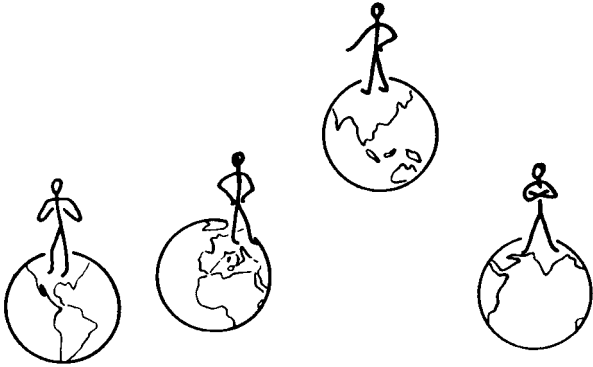

This is good only if they have bridges between their separate worlds and get to know enough about each other.

alone: by one's self (oneself); not with others.

nations: countries and peoples under independent government.

independent: not dependent.

A little knowledge about
other nations—too little
knowledge—can make
them seem bad.



But we can't turn the clock back to yesterday when nations could keep to themselves and live without any knowledge of or help from other countries.

The thing to do now is to get more knowledge about other peoples. And knowledge of other languages is necessary for this. We need many more people with a deep knowledge of other languages than their own.

We have to know a language well if we are to know what people who use it mean and think.

have to: must.

are to: are to become able to.

In English—as in any other language—we do not always say what we mean or mean what we say. This is true of some of the things we say every day. For example: “How do you do?” “How are you?” This is what people say on meeting. Sometimes they stop and shake hands. “How are you?” looks like a question. It is written with a question mark after it. And sometimes “How are you?” is a question. One person may want to know if another is well or ill—how their health is—and so on.

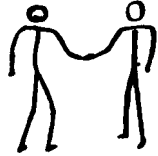

meeting: coming together.

shake hands: when two people shake hands each takes the right hand of the other in theirs for a second.

health: one who has good health is healthy. One who is in bad health is ill or sick much of the time. Taking care of the health of the public is an important part of the work of good government. Care of the health of everyone in the world is becoming increasingly necessary to all nations. The World Health Organization (WHO) was started in 1947.

will shake

shake(s)

shook, shaken

When these are questions they are almost always said as if the person who says them means them as questions and wants an answer.



But most of the time they are said in a way which does not ask for any answer. When these words are said so, we do not answer: "I am tired," or "I have a bad cold," or "I am not well." We say the same thing back to the other person: "How are you?" or "Hello!" Such words are like a smile or a wave of the hand.

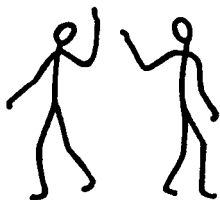

In the same way, when we meet someone in the morning, we may say "Good morning!" The weather may be very bad but we say "Good morning!" and the other person will say "Good morning!" back to us. We are not talking about the weather or about how good or bad the morning is.



tired: in need of a rest.

meet: come together with.

will meet

meet(s)

met

Again, when people are parting, they may say: “Good morning!” or “Good afternoon!” or “Good evening!” or “Good night!” to one another in place of “Good-bye!” They are not talking about the weather but saying “May all be well with you at this time!”

You will find few people today who know that “Good-bye!” is a short way of saying “God be with you!” But in times past, when religion had more place than it now has in education, a child could be taught this very young as part of a knowledge of English.

parting: separating, going away from one another.

afternoon: part of the day which comes after noon (12:00) and before night.

evening: late afternoon and early night.

noon: (12:00) point of time between morning and afternoon.

God: in Christian teaching, that Being on Whom all other beings depend.

religion: thought, feeling, desire for, interest in our deepest needs.

There was a teacher who tried to teach all this. Her students seemed to take in what she taught them. They said back to her all together: “When you say ‘Good morning!’ to us, we say ‘Good morning!’ to you.”

Next morning on her way to school, she saw one of them coming. She said to herself, “Now I will see if he has learned that point about ‘Good morning!’”

So she said to the young man:

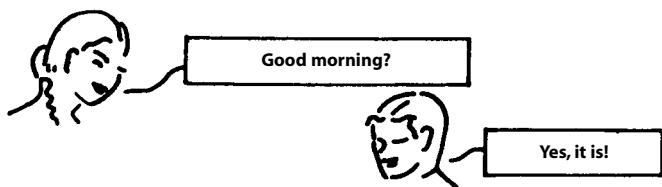

She had said “Good morning” to him with a question in her mind: “Will he say ‘Good morning!’?” She had asked a question and he had answered it.

The teacher said to herself: “I must have seemed to be asking a question, so he gave me an answer. Next time I will do better.”

At that minute she saw another student coming. She said to herself, “Let me try again.”

So she gave the young man a friendly smile and said,

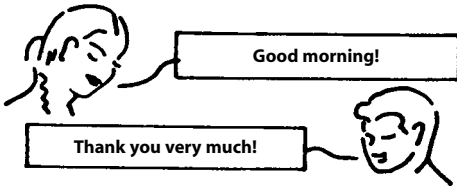

“What was wrong then?” the teacher asked herself. “I must have said it as if I were giving him something. That was why he thanked me. Next time I must keep that out of my voice.”

She saw a third student coming. This time she wanted the answer “Good morning!” so much that her voice became hard and sharp.

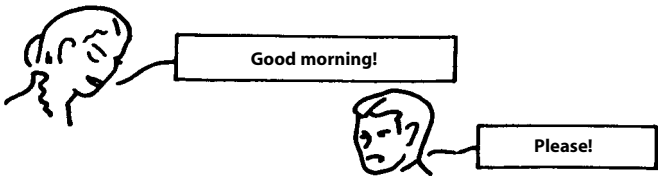

You see how little one person may know what is in another’s mind even when the other is trying to show him.

thank: say it was good of others to have done what they did; give them thanks; say “Thank you.”

please!: may it be your pleasure; may it please you.

will thank
will please

thank(s)
please(s)

thanked
pleased

When people are from very different countries with very different ways, it can be hard for them to understand one another. Not very long ago the number of people who knew anything about people in other countries was very small. Few people went far from home or took much interest in other countries.

Today all this is changed. Every day, we hear more and more about other countries and about how bad their governments are. They hear about the strange and wrong ideas other countries have of them.

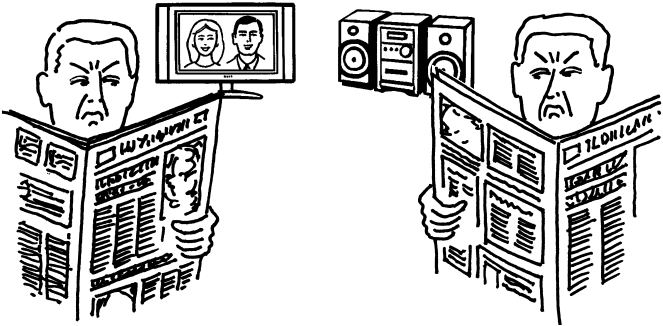

If we knew them better, we would see that people everywhere are very much like ourselves: not very good or very bad, but in between and able to become better or worse than they are. Our minds are as like one another as our bodies are.

to understand a person: to see what his ideas and feelings may be.

will understand

understand(s)

understood

We say: "The earth is getting smaller." It is the same size as it was, but we can go about it more and more easily. Many more people travel outside their own countries every year.

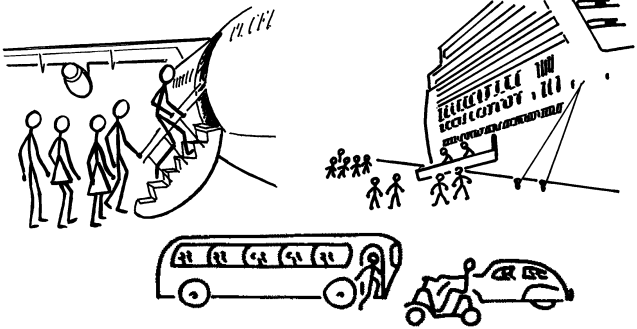

We can get news today from any part of the world in a few seconds, though we may not always understand it.

Many more ideas, right or wrong, about other countries are in people's minds.

Most of this interest in other nations and places is good if it goes deep enough. We need to know more. If we can keep our heads on our shoulders, the wider knowledge and experience which are coming will help the world to better days.

understand something: have a clear, true idea of it.

travel: make a journey, go.

will travel

travel(s)

traveled

The earth seems to be getting smaller because our experience is getting wider. All sorts of new ways of living and new ways of doing things have come to us in the last fifty years.

Stranger things are coming.

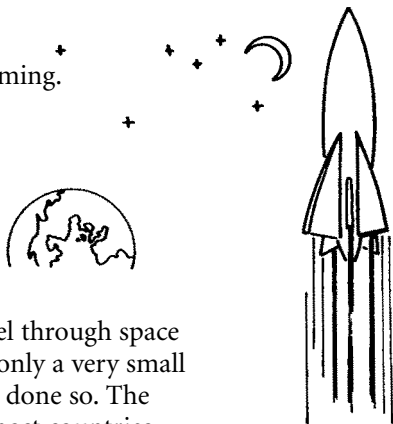

People can today travel through space to the moon, though only a very small number of them have done so. The price is too high for most countries to send even one person there for the present.

What is Space? That is hard to say. It is equally hard to say what Time is. We and the sun and the moon and the stars are all in Space and Time. But no one understands what Space and Time are. Not even the best philosophers are clear about them.



These two men know that they have a space between them without being able to say what Space is.

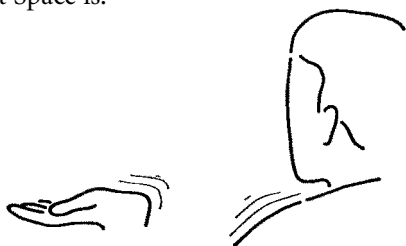

There is not enough space in this car for all these travelers. They know that this is so, though they cannot say what Space is.

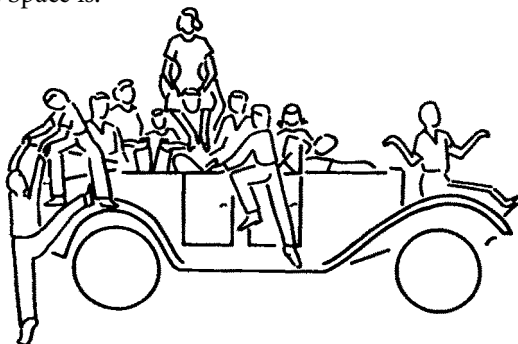

There is more space free on this page than on some other pages of the book which take longer to read.

traveler: person who travels.

It is equally hard to say what Time is.



This man has time on his hands.

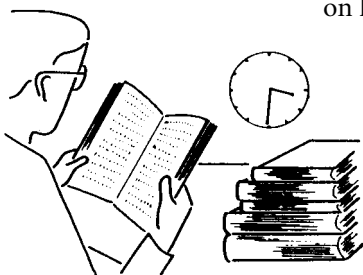

This other man has not enough time for his reading.

The same amount of time may seem very short to one person and very long to another. A person's sense of time changes as their feelings change. Some days go by much more quickly than others. Some hours seem as if they would never end. Some are past before they seem to have begun.

Most people find that time goes by more quickly the older they get.

never: not ever.

end: come to an end; opposite of begin.

will end

end(s)

ended

Our ideas about Space and Time are changing. Today we can fly round the world in twenty-four hours or less.

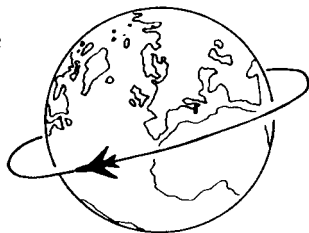

The earth turns round on itself in twenty-four hours.

A person in an airplane flying west at 1000 miles an hour (m.p.h.) would see the earth turning. The sun would seem to be in the same place in the sky. The earth would turn below the airplane.



Two hundred years ago scientists thought that the world was only about 6000 years old. Now scientists say that it is nearer six billion years old and that humans are at least five hundred thousand years old. But we have been able to fly only in the last one hundred years. The invention of the airplane is an invention of the twentieth century.

Air travel would have seemed very strange two or three thousand years ago, to men keeping their sheep on the mountainsides. All these changes are the outcome of the great step taken in the invention of numbers.

Before men could count, how did anyone know which were his sheep and which were another man's?

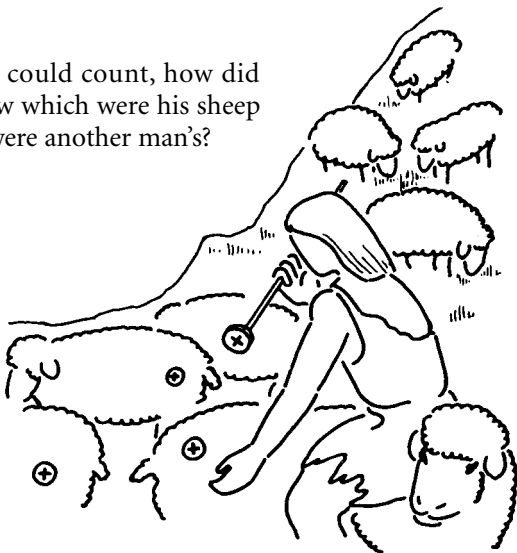

He put his mark on his sheep. He was their owner. They were his own sheep. He owned them.

Sometimes he gave his sheep names, and then he would go through all the names—with his sheep—to see if they were all there.

Before the invention of writing how did people keep records? They made pictures on soft earth or sand. But rain and wind and waves quickly washed away such records. Smooth stone or wood was better, and best of all, the smooth stone walls of caves whose roofs kept the rain and wind away.

It may be that the drawings copied on page 142, or others like them, were records made by early humans. (Someone recording animals on a cave wall may have taken pleasure in the drawing for itself and become the first artist.)

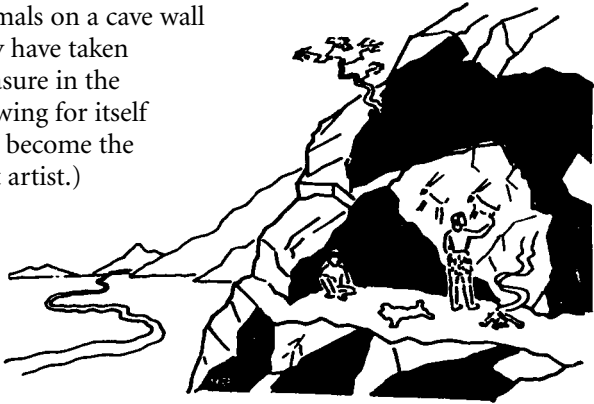

cave: deep hole or hollow in side of mountain. People lived in caves long before they knew how to build themselves houses.

wash away: take away by the motion of water over something.

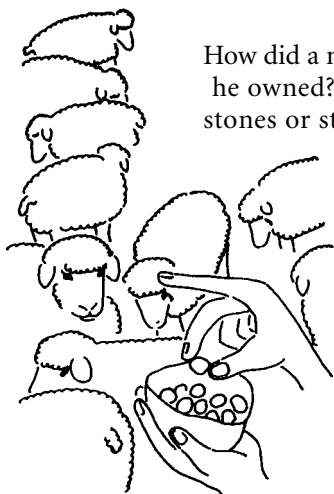

How did a man know how many sheep he owned? Sometimes he used small stones or sticks, putting one of them into a bag or pocket for each sheep he had.

When he came to the end of his sheep, the number of stones in the bag was the same as the number of his sheep. The stones and the sheep were equal in number. The stones gave him a record of how many sheep he owned. When a sheep died he could take a stone out of the bag. And when lambs were born he could put in another stone for each lamb.

lamb: baby sheep, young sheep. In the U.S.A. meat from sheep is lamb. In Britain, the word mutton (from French for sheep) is used for the meat of full-grown sheep.

Sometimes a record was made by taking a sharp, hard stone and making cuts on a stick. The number of cuts in the stick equaled the number of things to be recorded.

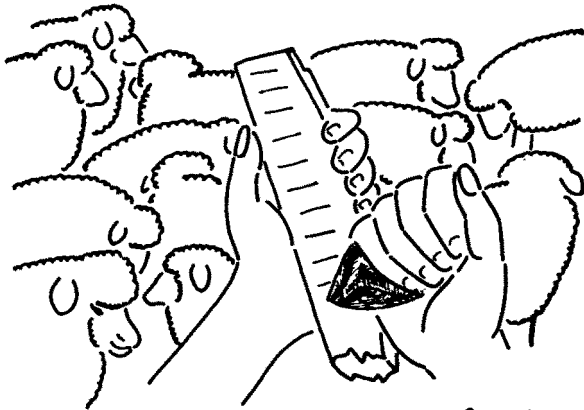

Then the stick was cut in half down the middle so that each half had half of every cut on it. The two half sticks were tallies. If they were put side by side, the halves of the cuts came together. They tallied. One man took one tally and another the other, and both then had the record.

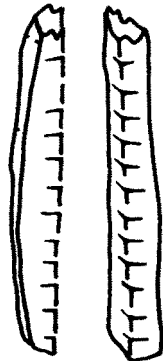

tally: one sort of record.

Will equal
will tally

equal(s)
tally(les)

equaled
tallied

Tallies are some of the earliest and simplest records of the numbers of things. They tell how many things have been counted.

Even today in a bank a person who takes money in and gives it out is sometimes named a teller.



The shelf or table where the teller works is a counter. On it the teller does the counting of the money coming in and going out, and keeps a record of all this in an account book.

A person who makes a statement tells something. Most banks make a statement every month to each person banking with them to tell them what their account is. The statements tell them how much money they have in the bank at that date. Then both they and the bank have the record straight.

To get these statements ready, the banker has to take the amount of money given out (for any one person) from the amount of money put in.

tell: give an account of, give a story to someone.

straight: in this sense, right.

will tell

tell(s)

told

Bank tellers must keep a complete record of the money they take in and give out. This is their way of making certain that their accounts are in order. Banking is a very important sort of business. A bank must keep all its accounts in good order and the statements which the bank makes must be true statements.



STATEMENT OF ACCOUNT—TOWN BANK				
Mr. John Smith, 11 First Street				
OUT	IN	DATE	NO.	BALANCE
		5/ 3/04		860.83
10.00		5/ 5/04		850.83
	62.55	5/ 7/04		913.38
	50.00	5/14/04		963.38
80.00		5/15/04	2	883.38
42.94		5/15/04	3	840.44
15.00		5/18/04	4	825.44
	30.00	5/21/04		855.44
20.00		5/24/04	5	835.44
41.95		5/26/04	6	793.49

in order: with nothing wrong. Things are in order when in their right places. When one is in good health, one's body is "in order." When one is ill, it is "out of order." The work of the police in a country is to help to keep law and order.

making certain: proving to oneself and to others.

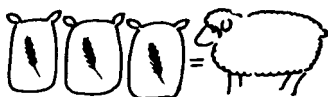

How do we know whether someone is telling the truth? If a man tells another that he will give him three bags of grain for one sheep, the other will know whether he told the truth when he gets the grain or doesn't.

The man may, or may not, have meant to give the grain when he said he would. He may not have meant to say anything but the truth. But if he did not give the grain later, he was not true to his word.

We sometimes know whether a man is telling the truth (and will be true to his word) by the look in his eye, or the sound of his voice.

whether: (See page 47.)

truth: things which are true. A man tells the truth when what he says is true.

In early times, before people invented money, they did all their business by exchange of goods. People traded with others by exchanging goods they were willing to give up for goods they wanted more. Exchange of things still goes on in some parts of the world today.



After the invention of money, trade increased. It is our experience that money can be a great help in making trade easier and in keeping business in better order. If you want something and have the money for it, you can buy it. You do not have to keep asking yourself whether you have something which the other person will be willing to take in exchange for what you want.

exchange: giving one thing for another. (See page 97.)

willing: if you are willing to do something you will do it if you have to.

still: up to the present time.

trade: exchange of things for other things or money.

will trade
will invent

trade(s)
invent(s)

traded
invented

Early people did things with their hands which we do with instruments or by machine.

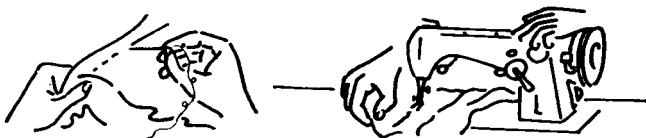

Fingers were made before forks.



Among their early uses, fingers made good counters. We still use the number ten as the key to our number system because we have ten fingers.

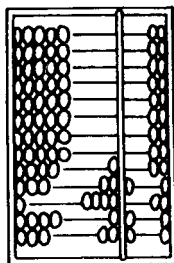
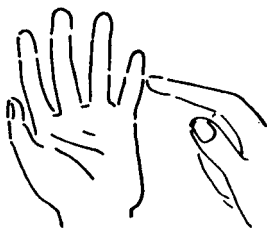

Many people today still count on their fingers, and others use an abacus. An abacus is a frame with little balls threaded on wires. The balls are pushed from side to side on the wires. The invention of the abacus made it possible for the balls on one wire to represent the numbers up to ten, on the next wire tens up to a hundred, the next, hundreds, and so on.

The most important number in the number system used commonly today is zero (0). Zero is so easy to use that it is hard to understand why it was not invented long ago. It is thought to be not much more than a thousand years old and no one knows who invented it.

We use zeroes to change numbers to others. Zero to the right of a number makes it ten times its size. Two zeroes make it a hundred times its size. Six zeroes after one make it mean one million.

Schools today teach a child to add, subtract, multiply and divide numbers. Here are examples.

addition:	$5 + 5 = 10;$	$6 + 3 = 9$
subtraction:	$5 - 5 = 0;$	$6 - 3 = 3$
multiplication:	$5 \times 5 = 25;$	$6 \times 3 = 18$
division:	$5 \div 5 = 1;$	$6 \div 3 = 2$

will add
will subtract
will multiply

add(s)
subtract(s)
multiply(ies)

added
subtracted
multiplied

People made their way about on the earth, over mountains, down rivers and across seas long before they had a number system or could make or use a compass. Nobody knows who invented the compass. The Chinese, Arabs, Greeks and Italians, among others, say they did.

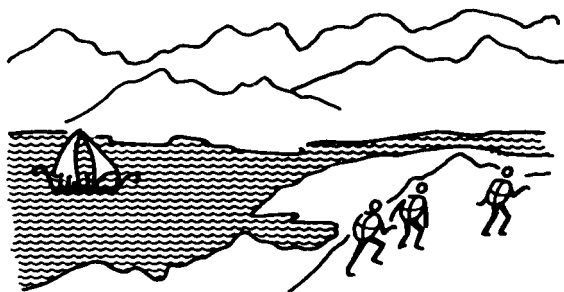
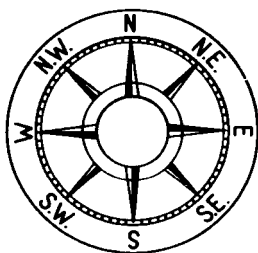

When people became able to work out the relations of lines and spaces to one another, and could measure distances and angles, the science of geometry, earth measuring, began.

People went on then from measuring fields and bits of land, to measure the size of the earth itself.

compass: instrument showing the direction of something in relation to the north.

geometry: science which looks into the relations of lines and spaces to one another, from two Greek words, *ge*—earth, and *metron*—a measure.

The Greek scientist Eratosthenes (276–194 B.C.) was the first man to work out the size of the earth.

He heard that there was a deep well into which on one day of the year the sun's light went all the way down to the bottom. He took the angle of the sun at the same hour from another place 500 miles from the well and worked out by geometry that the earth was about 29,000 miles round.

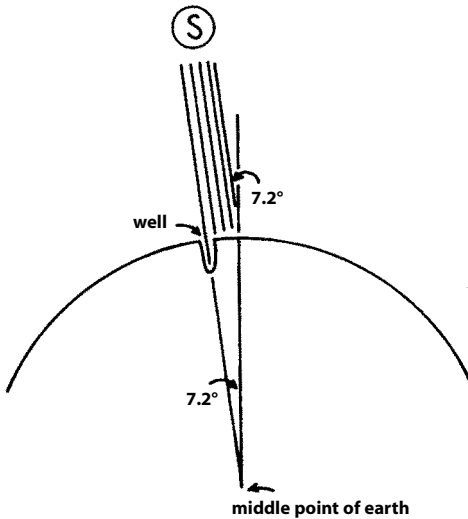

The size of the earth, scientists now tell us, is about 25,000 miles round.

well: here, a deep hole in the earth from which water is got.

bottom: lowest part, opposite of "top." This is the bottom of the glass.



Geometry starts with ideas about lines and spaces.

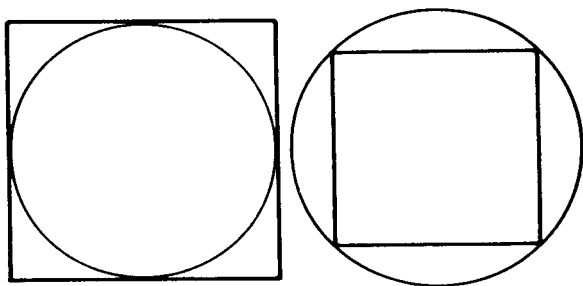

Here are two circles and two squares.

The circle on the left is inside a square. That is the relation of that circle to that square.

The square on the right is inside a circle. That is its relation to the circle.

These are facts about the circles and squares on this page.

Statements which tally with facts are true. Statements which don't tally with facts are not true. It is untrue that the square on the right is outside the circle. To say it is would be to make a false statement.

fact: it is a fact that the word *fact* has four letters in it.

untrue: not true, false.

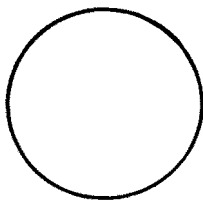

What is a circle?

It is easy to see what it is, but not equally easy to say what it is. Here is a straight line half an inch long. If you could turn the line right round like the hand of a watch, it would have covered a circle. One end of the line would have to keep in the same place while the rest of the line was turning.

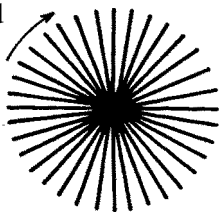
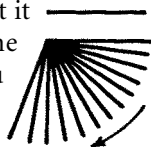

Here is another line the same length; it is half an inch long. If you could pull it down like a map on a roller a distance equal to its own length ($\frac{1}{2}$ inch) then it would make a square with sides half an inch long.



This is not a square though its sides are equal. Why not? Because its angles are not right angles.



This is not a square though its angles are right angles. Why not? Because its sides are not all equal.



rest: in this sense, the other parts.

length: distance long.

Six thousand years ago in Egypt there were people who saw how to measure their land through their knowledge about squares and triangles.

How large is this square? What is its size?

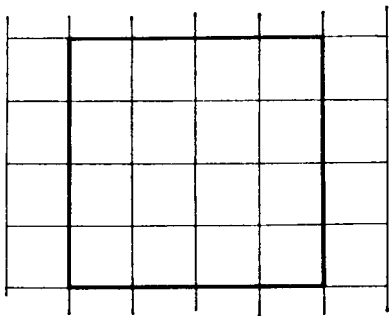

Because the square is on squared paper, it is easy to see what its size is. We count the number of small squares in the large square. This number is the area of the square.

If the small squares were an inch square, the area of the large square would be sixteen square inches. If they were one foot square, the area of the large square would be sixteen square feet. If they were one yard square, the area of the large square would be sixteen square yards. Whatever the unit of measure used the relation of side to area is the same.

area: see above on this page.

unit: division of a measure used as one.

People took the first units of long measure from their bodies. The end of a man's thumb is about one inch long. A tall man's foot is about twelve inches or one foot long.

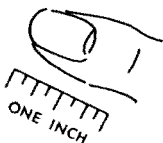

A long step is about three feet or one yard long. The simplest way of measuring a short distance is to step it.

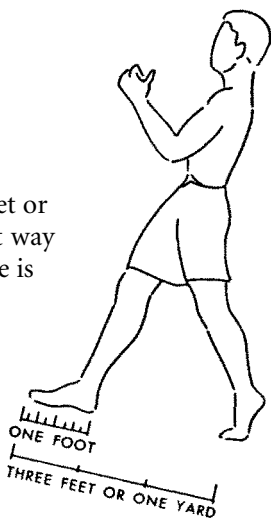

These units of long measure have been a great help to us. They have made it possible for us to measure and compare lengths and areas and volumes. Measuring lets us build a room the size and shape we want it, for example, twenty feet long, sixteen feet wide and twelve feet high.

volume: cubic space. The volume of the cube on page 121 is one cubic centimeter.

shape: outline. All squares are the same shape but they can be different sizes. All circles are the same shape but not all triangles.

will step

step(s)

stepped

Sometimes a family's fields were not square. Some of them were like this:



or like this.



People walked across their fields; they planted them and took in the grain. They knew how much land they had from working them before they could measure them.

They saw that a field like this



was the same size, though not the same shape, as a field like this

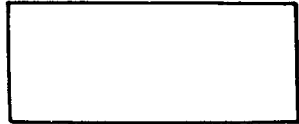

before they knew that they could measure how long and how wide a field was, and then get the area by taking one measure times the other.

will plant

plant(s)

planted

They saw that they could get half a field in this way ...

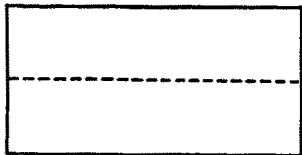

or in this way,

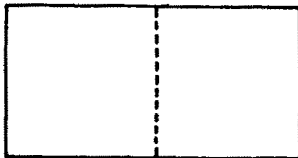

before they knew how to measure rectangles or triangles.

Can you see whether these two fields have the same area?

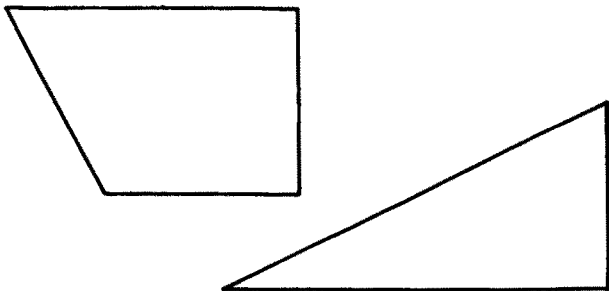

Put in lines to prove that they are or are not equal in area.
The answer is at the bottom of page 178.

rectangle: a rectangle has four straight sides and four right angles.

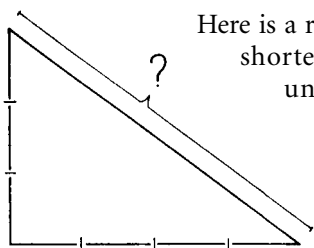

Here is a right angled triangle. The two shorter sides are three and four units long. How many units long is the longest side?

Can you tell without measuring? How?

About 2500 years ago (500 B.C.) a great Greek, Pythagoras, proved that the square on the longest side of any right angled triangle is equal to the squares on the other two sides added together. We can use his discovery to get our answer. We multiply the length of each of the two shorter sides by itself. We add the answers together. Then we find a number which, multiplied by itself, gives us this number.

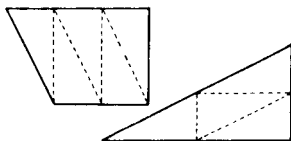

The answer to the question on page 177 is "no."

Here is the answer:

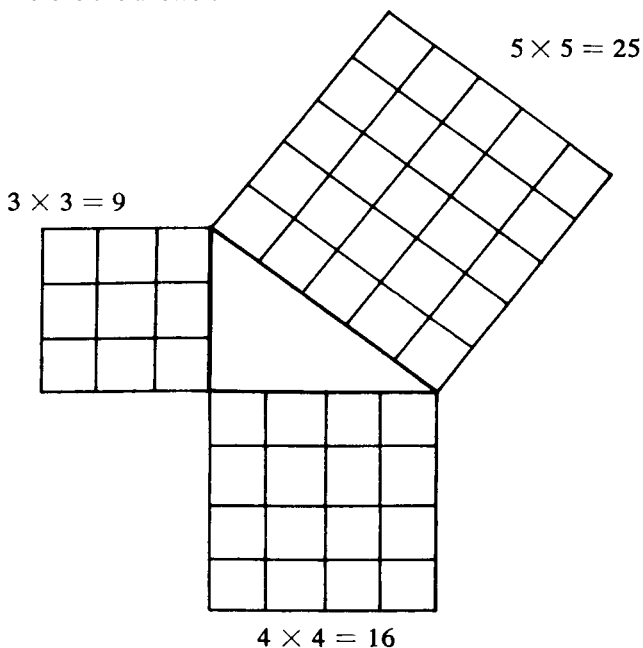

$$9 + 16 = 25 = 5 \times 5$$

When we multiply a number by itself we “square” it. Any number is the square root of its square. 5 is the square root of 25.

to square: to multiply a number by itself.

will square

square(s)

squared

It was not until many centuries later that people put this knowledge of geometry to wide use. The development of science had to wait until the days of Galileo and Newton. In the last three centuries our ways of living have been and are being deeply changed by science. These changes can be compared only with three or four great earlier steps in the history of human development. These are the birth of language, the use of fire and farming, and the invention of writing.

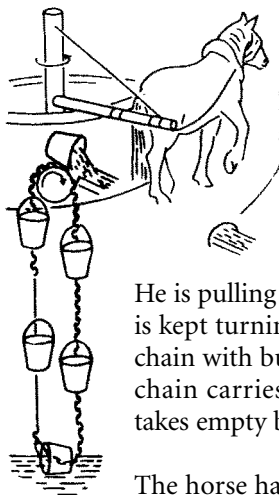

Here is a horse walking round and round the mouth of a well.

He is pulling on a strong stick of wood which is kept turning by his motion. This moves a chain with buckets on it. The motion of the chain carries buckets full of water up and takes empty buckets down.

The horse has a cloth over his eyes to keep him from seeing that he is walking all the time in a circle. Would he stop if he knew he was going round in circles?

Today machines are the work horses. They are doing what people gave all their days to doing in the past. Muscles get less tired in the machine age, but they often get more tired in other ways. We are finding that we need more and more time to work out the direction that our lives may best take. We need a new design for living.

People carried water from springs and rivers, and pulled it up by hand from wells, long before they learned even how to turn a chain round a wheel. They put a cord round a wheel and turned the wheel round because that was less hard work than pulling full buckets up the well by hand. The steps have come slowly because each has to be taken before the next. A next step was to put another bucket on the other end of the cord so that an empty bucket went down as the full one came up.

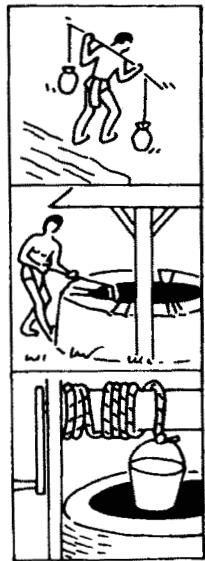

often: time after time.

design: picture of what can be done. Before a house or a complex machine is built, the builders must have a design (a "blueprint") before them.

In one of the well-known Uncle Remus stories, Br'er Rabbit, a little animal who always gets the better of the other animals living near him, gets into a well-bucket ...

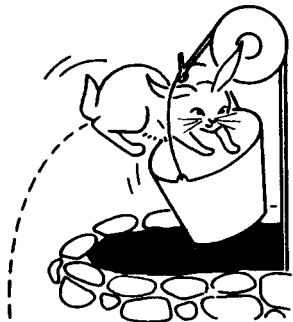
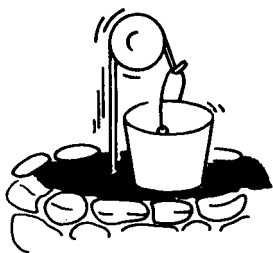

and down he goes to the bottom of the well. As his bucket goes down, the other bucket comes up empty.

“How am I ever going to get back up?” he says to himself.

After a while, Br'er Fox comes along, looking for Br'er Rabbit. “What are you doing down there, Br'er Rabbit?” he says, looking down into the well-hole.

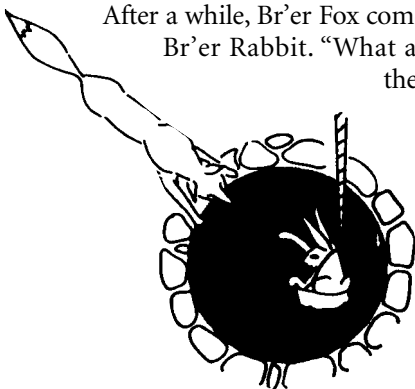

“I’m doing a little fishing. There are hundreds of fish down here.”

“How can I get down there?” says Br’er Fox.

“Just get in the bucket, Br’er Fox. It’ll bring you down in no time,” says Br’er Rabbit.

And as the
fox goes
down ...

up comes Br’er Rabbit to the top
in his bucket, as he wanted to do.

The two buckets go by one
another on the way. “Good day,
Br’er Fox, some go up and
some go down. A happy landing
to you,” says Br’er Rabbit with a
smile and a wave of the hand.

Such stories about animals are as
old as any inventions.

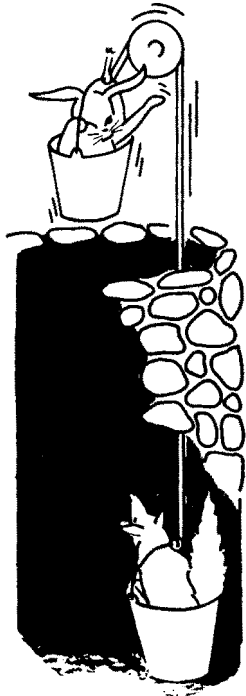

just: in this sense, only.

bring: make ... come; come with.

landing: coming to land, to earth, to harbor.

will bring

bring(s)

brought

Here is a water wheel being turned by water power.

The weight of the water falling into the buckets turns the wheel, and the wheel, in turn, turns great round stones (millstones) for crushing (milling) grain and making it into flour.

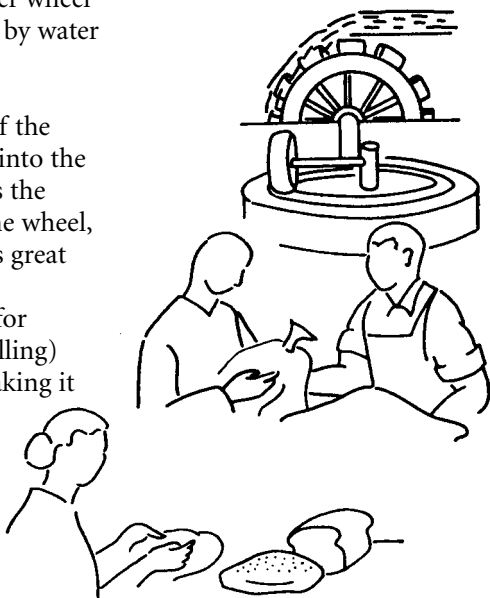

Men took their grain to the miller to be made into flour. Then they took the flour away and their wives made it into bread.

People did all this everywhere in the old days before the invention of steam engines and electric power.

mill: factory for making flour.

miller: man who works in a mill.

Here is a windmill which does the same sort of work.

The wind pushes the sails of the windmill round. The work of the windmill is dependent upon wind. When there is no wind the miller cannot make flour, because there is no power to turn the millstones round.

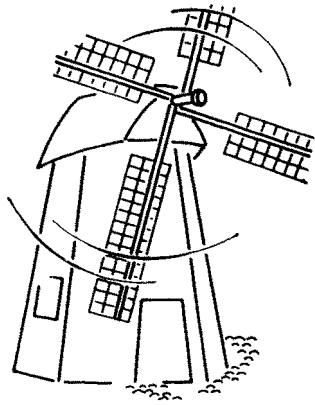

There is an old song about a miller who lived by himself and could be heard singing a song all day long.

“I care for nobody, no not I
And nobody cares for me.”

sang the miller.

What he meant was that he did not love anyone and that nobody loved him. He had no hopes or fears. He did not hope for anything or fear anyone.

push: give a push to.

hope: our feeling when we look forward to and desire something.

fear: opposite of hope; feeling about things which we think may take place, the thought of which makes us turn white and shake all over.

will push
will hope
will fear

push(es)
hope(s)
fear(s)

pushed
hoped
feared

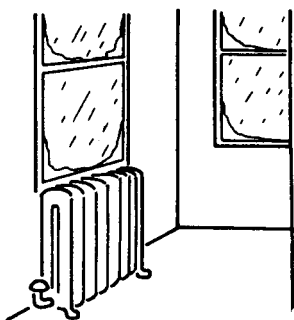

In many parts of the earth the climate is either too hot or too cold for humans most of the year. But it is now possible to put automatic controls over temperature into houses, offices, and work plants.

Here is a thermostat which keeps the temperature of the air as high or low as we want. We put the pointer at 70°F; then the thermostat will keep the temperature of the room near 70°F, the point on the scale to which the pointer points.

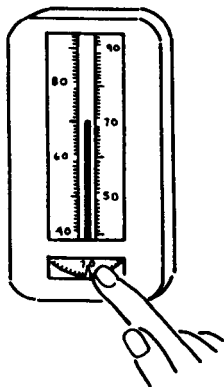

climate: weather through the year; temperature, amount of rainfall, amount of water in the air and so on.

thermostat: instrument for keeping automatic control over temperature.

pointer: person or thing pointing.

will point

point(s)

pointed

A thermostat is designed for this purpose. Its design makes use of our knowledge of what metals do when heated.

This is the way it works.

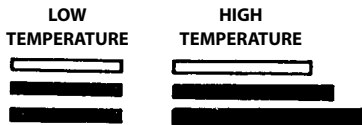

Different metals get larger by different amounts as they are heated.

Two long thin pieces of such different metals are bent together like this inside the thermostat.

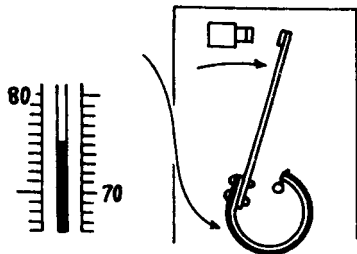

When the temperature in a room goes above 70°F the metal on the outside gets longer than the metal on the inside. This moves the arm to the right and shuts off the fuel in the heating system of the house.

for this purpose: to do this work.

purpose: a thing's purpose is what it is designed to do.

When the room gets too cold, the piece of metal on the outside gets shorter and moves the arm to the left. This turns on the heating system and more fuel is burned to warm the house. The purpose of putting a thermostat into a heating system is to control temperature.

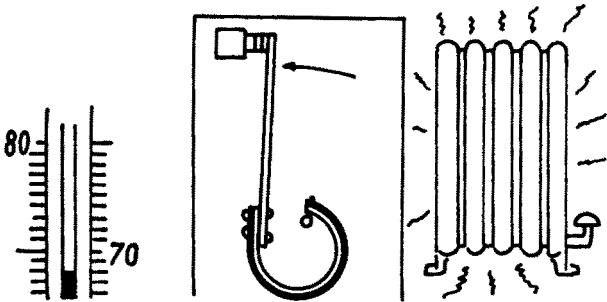

In hot climates what is important is to cool houses by sending fresh cold air through them. We can control the temperature of the rooms and in addition dry the air and have a climate of our own making indoors. Every ice chest has a climate of its own inside it. It is strange and surprising, but true, that ice chests are kept cold by using heat. The heat is supplied by electric power or by burning gas. Scientists tell us that before long we will be using the sun's heat to cool buildings. This will make life in hot climates much easier.

There are many other sorts of automatic controls.

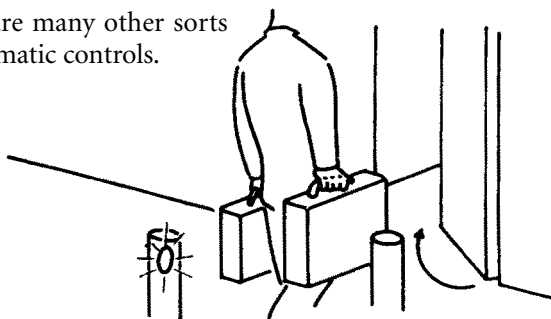

In this hotel a door is automatically opening to let a man go through. His body has shut off the light from an “electric eye” as he walked past it.

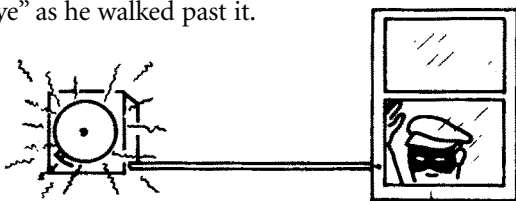

In this bank a bell is ringing loudly because someone has touched a window. The man was hoping to break into the safe.

Many offices, banks, stores and work plants are kept safe at all times by such automatic watchers.

ringing: sound made by a bell. We say that a bell rings.

safe: steel box where money and important papers are kept. They are safe when locked in it, if no one breaks it open.

hotel: building where people can get rooms for money.

will ring
will touch
will break

ring(s)
touch(es)
break(s)

rang, rung
touched
broke, broken

Here is a night watchman in a motion picture studio (plant) keeping it safe from danger of fire at night.

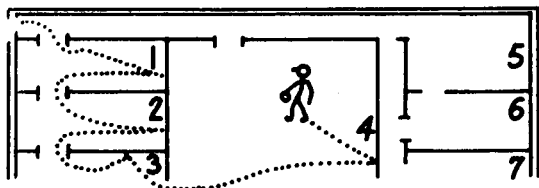

He has his time clock with him. He walks all night long through the plant from one station to another. At each station he pushes his time clock against a key which is fixed in the wall.

This key prints a number on a long narrow roll of paper which is moving all the time through the lock of the time clock.



In this way the time clock makes a full record of whether and when the watchman went to each station in the studio in turn. The time at which he was at each one of them is recorded. If a number is not recorded, that is proof that the watchman did not go to that station.

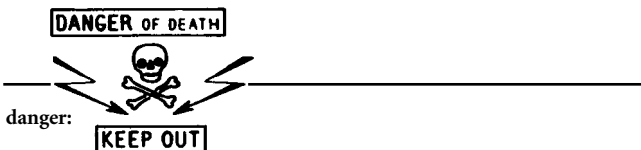

		1:11
3		1:12
		1:13
		1:14
		1:15
		1:16
4		1:17

This record is necessary before the insurance company will pay for damage done to the plant by fire. The insurance company needs to know where the watchman was all through the night.

The motion picture company pays insurance money every year to the insurance company. In exchange the insurance company will pay for any damage to the building done by fire. But the motion picture company is responsible for keeping the studio as safe as possible from fire. The night watchman with his time clock is part of the system of keeping the studio safe from fire.

responsible: if you are responsible for doing something, you have to do it.
If you give your word that you will do something, you become responsible for doing it.

insurance: making safe from danger; making good when something goes wrong.

company: business group.

damage: if a thing is burned, broken, or put out of working order it is damaged. Damage is done to it.

will damage

damage(s)

damaged

Here is a more fully automatic part of a system of controls against fire. Some metals melt at low temperatures for metals. Thin lengths of such metal are placed at many points in the plant. A fire starting near one of these points will quickly melt the metal.

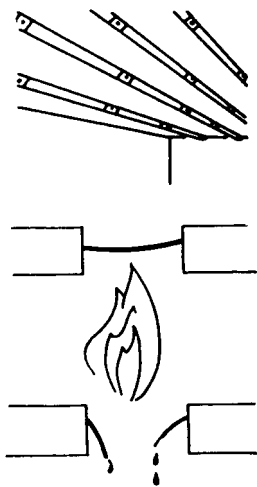

This starts an electric system working. It opens outlets through which water comes down from the ceiling to put out the fire.

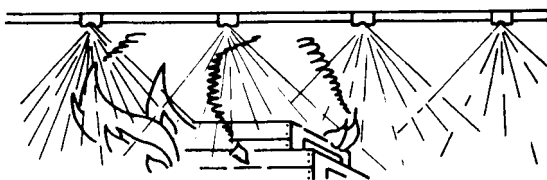

The price of such a system may be high, but it is much lower than the price of a new building. Such insurance is cheap at the price.

melt: become liquid, as ice becomes water.

ceiling: inside of the roof of a room.

cheap: low in price for what you get.

will melt

melt(s)

melted

Much of the work in present-day factories has to be automatically controlled. The much-talked-of Assembly Line was a first step in this direction. It lets us make automobiles and many other things much more cheaply than they could be made before.



An Assembly Line is a moving line of parts of whatever is being made. Each worker (human or machine) does one thing (adds or changes some part) to each automobile (or whatever is being put together) as it goes by. The work of each is dependent on what has been done before. They are parts in an over-all design with an over-all purpose.

If you make workers into machines for short working hours you can free the rest of their time. What for? To what purpose? What are we designed to do? This new free time has been given us by the workers and thinkers of the past. We have to think about what we will do with it, and about the best possible use of it.

free: make free.

will free

free(s)

freed

It seems sometimes as if we want very much to put an end to waiting on one another. There are many ways, for example, of making the serving of food in restaurants more or less automatic. One of the causes of the high price of food in restaurants is the use of waiters and waitresses. One



waitress can serve only a small number of people, if she has to go to and from the tables with trays. And fewer people than before are interested in doing this sort of work even when the hours are short, the pay is good and the work not too hard.

In present-day living more people than ever before eat at restaurants. Many families who used to have servants now do all their own housework.

serve: give out, put before, do things for.

waiter: man who serves at table or in a restaurant.

waitress: woman who does the same.

servant: one who serves others, for example, a person who is paid to do housework.

will serve

serve(s)

served

There are ways of making restaurants self-serving, that is, of getting the public to do more of the work so that fewer waitresses are needed and less time is wasted in waiting to be served.

The nearest thing to complete self-serving is the AUTO-MAT. Food and drink are put into boxes with glass doors in front.

You look at the food.



If you want what you see, you put in the right amount of money and the door is unlocked so that you can open it.

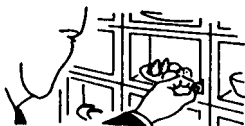

You take the food out and shut the door again.

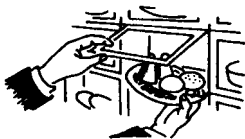

Fresh supplies of food are put in the boxes as they are emptied.

More and more use is being made, in public places, of automatic machines which sell food, cigarettes, drinks, stamps, or even books.

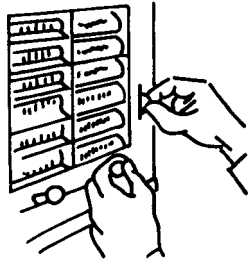

To make buying and selling simpler and more automatic is important. Too many people have to give up too much of their time to shopping for their families. Some of them use up a large part of their lives going from shop to shop to get what they want and waiting in line for people to serve them. Serving themselves frees them from this.



shop: store. In the United Kingdom *shop* is used and in North America *store*; but you go shopping in both places—that is, you go to stores to see what you can buy.

will shop

shop(s)

shopped

There are great food stores today where every sort of food: meat, bread, butter, milk, vegetables, flour, sugar, salt, fruit—whatever it may be—is put out, each in its place, on shelves for everyone to help themselves. You take what you want, put it in a little cart if there is much of it, and take it to a control counter where you pay for it. An automatic adding machine is used to give the amount you will have to pay and to make a record of the things you have bought.



The adding machine prints the price of each thing on a roll of paper. You see how much you are paying for each thing you are buying and how much what you have bought adds up to. Then you get a list of the amounts recorded and the store keeps a copy. These records of everything sold help to keep the business of the store in order.

In many businesses accounts are kept by machines and the records are photographed. When there are millions of different facts to be taken into account, and records of them to be made, machines can work far more quickly than people.

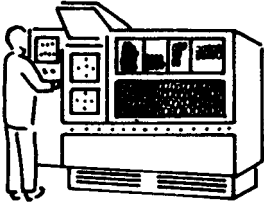

The newest and greatest accounting machines (computers) can do far more work in a minute than the quickest human could do in a year. But the machines and the questions put to them come out of human minds and are controlled by us.



will photograph

photograph(s)

photographed

It was James Watt who in 1788 invented the Flyball Governor for steam engines as a way of making the engine able to keep control over its own rate of motion. This was the invention which made the steam engine a safe machine.

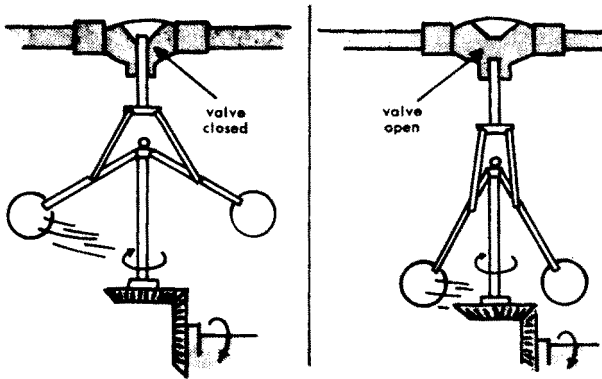

The two balls are kept flying round and round by the motion of the engine. As it goes more quickly they fly farther out and this shuts down the supply of steam coming to the engine from the boiler. When the engine goes more slowly the balls fly lower and this opens up the shut-off (valve) and lets more steam through the pipe to the engine.

The governor of a steam engine took its name from the fact that it governs the engine as a government governs a country. A government in a free country is a group of men and women to whom the people give the

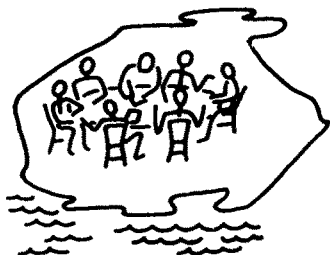

power to govern them. In free countries there is government of the people, by the people, for the good of the people. The government is the instrument by which the country controls itself. In a free country the people can change the government: they can take the power away from one group and give it to another. And there is a limit to the powers that any government is given or can take.

govern: be in control of.

limit: the point, line or edge where something comes to an end. To limit is to put a limit to.

will govern
will limit

govern(s)
limit(s)

governed
limited

In a free country the men and women in the government are dependent upon the people and responsible to them for the use made of the power which has been given them. In any good system of government, there must be ways of controlling and limiting the amount of power anyone has, as the flyball governor controls and limits the output of the steam engine.

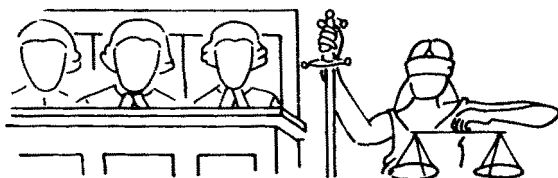

One of the chief controls over the power of a government is the law of a country. The law is a body of statements about what may be done to or by any person. In free countries all people are equal under the law which they are responsible for keeping. To help them to keep it there are police and judges.

judges: men and women trained in the law who are responsible for saying what the law is and what is to be done to those who break it.

Our bodies govern themselves in many ways (pp. 87–91, 115) but we have to control them consciously too. We have to be their judges and police, when necessary. But in a well governed country there is little work for police and judges. A good education develops the power of people to govern themselves in more and more complex ways.

As population increases and as people become more responsible for meeting their needs on a larger and larger scale, machines become more important. As the facts become more complex, machines (computers) are being used more and more to do all sorts of measuring, counting and controlling.

ELECTRIC BRAIN

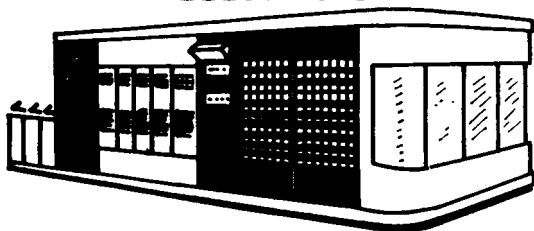

Can machines think? In a sense, yes. In another sense, no. They can answer a question if we have built into them the power to answer that sort of question.

education: (see *EP 2*, pp. 18-19) in a wider sense, ways in which we learn to become more able and responsible.

We can make machines work for us, but machines cannot tell us what that work should be. It is people who are responsible for the direction of the work.

A person has to know not only how to do things but whether to do them and when. A machine has only to do what it is made to do.

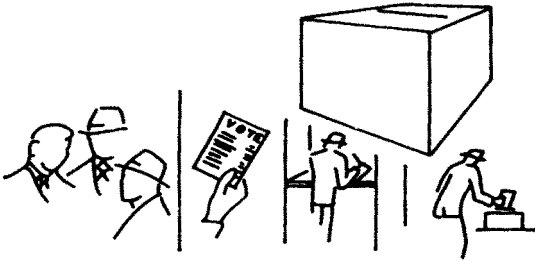

Free men and women have to make up their own minds about all important questions.

How does one learn to do this? By being with, talking to and watching others who are able to think for themselves one may see how to think for oneself. One gets better at it by trying. Education in this cannot start too early.

should: would best be; the work should be what would be best for people.

direction: (see *EP 2*, pp. 24, 78) seeing what should be done, giving the orders (directions) and being responsible for the outcome.

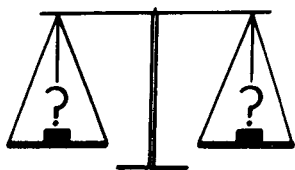

How do people come by their ideas about what is better and what is worse, about what things are important in life, what unimportant? How do they judge between things?

We have grown to what we are out of the past. We have come a very long way through change and growth from the first living cells.

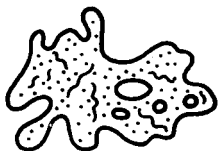

All living things, however simple, control themselves to some degree. Many cannot be said to have ideas but they have direction. Within limits they have self-control.

come by: get, in the sense of develop.

judge: come to a clear idea of what is best.

will judge

judge(s)

judged

Thinking is the most complex sort of self-control; and our brains, with which we think, are the most complex systems of feed-back. The thermostat and the flyball governor are about the simplest of them. In feed-back systems, effects control their causes.

In the thermostat feedback circle the effect of increased input of fuel is increased output of heat. This effect feeds back, through the thermostat, and cuts down the input of fuel when the increase becomes too great.

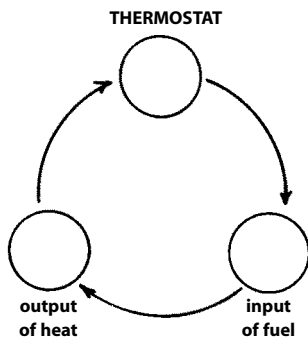

In the flyball governor circle the effect of more steam is more output of work from the engine. This effect feeds back, through the governor, and cuts down the steam when the engine goes too fast.

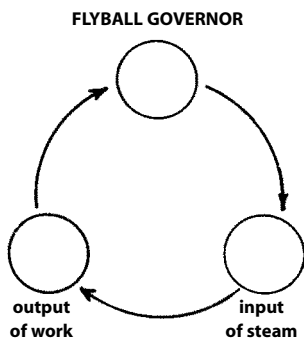

In the brain millions of feed-back circles are always controlling one another.

Our past is a very small part of all time, but it is a very important part.

How old are the stars? How old are the Sun and the Earth and the Moon? Nobody knows for certain. It is not possible at present to be certain about such great questions as these, but two things seem probable.

The universe is about five billion (5,000,000,000) years old.

It has been becoming more and more complex from the start.

certain: (see *EP 2*, pp. 143-144) two different meanings of "certain:"

1. You are certain about something when there is no question in your mind that it is so.
2. Something is certain (is a fact) if it is well-supported by all the rest of knowledge. We are sometimes certain (in sense 1) about things which are not certain (in sense 2).

probable: more than possible, less than certain.

If there are seven black balls and three white balls in a bag and you take one of them out without looking, it is probable that you will get a black one.



However we try to think of time, it seems certain that the earth is older than our minds can take in.

Things have been going on for a longer time than we can think of and they will go on and on through a longer time in the future than we can think of.

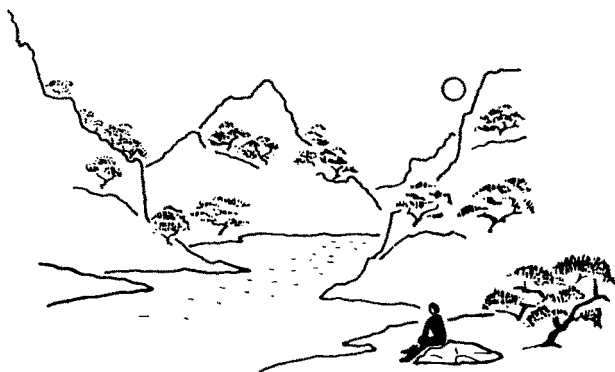

Seventy years seems a long life-time if compared with the present minute. But if compared with the age of a stone it seems no time at all.

There is a Chinese poem which says:

Quickly the years fly past forever,
Here forever is this spring morning.

poem: something said for the complete person (their thoughts, feelings, desires, hopes, fears ...) in the best possible way.

We have to think of Time and Space together: here and now, there and then. We cannot see with our eyes how far off in Time and Space the stars are, but astronomers can measure their distances. Their unit of measure is the light-year—the distance light travels through Space in a year. (See *EP 2*, pp. 76–77.)

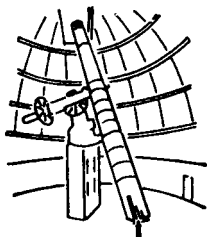

The greatest telescopes of today let us look two trillion light-years out into Space. The stars we see there are two trillion light-years away. We see them as they were two trillion years ago. We are looking into the past.

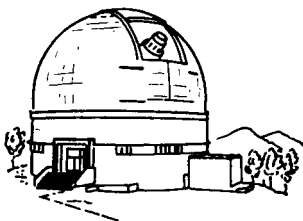

astronomer: scientist working in astronomy.
astronomy: science of the stars.

Let this curving line represent growth from simple to complex in the world.

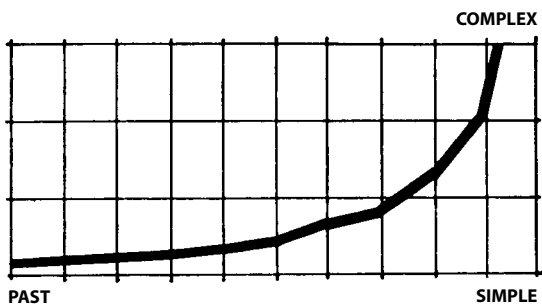

In this picture the past is to the left and we men and women of today are at the top of the curve.

Long, long ago, the only sorts of changes that took place were—so scientists say—very simple in comparison with the changes which are taking place in you now as you read this.

The curve represents the change from simple to complex. The higher it goes the more complex are the sorts of changes which are taking place.

In the beginning—as long ago, as far back in the past, as we can talk about—the only sorts of changes which took place, scientists say, were physical changes. They were the sorts of changes which the science of physics is about.

Here is a wheel turning round. Its motion is a physical change.

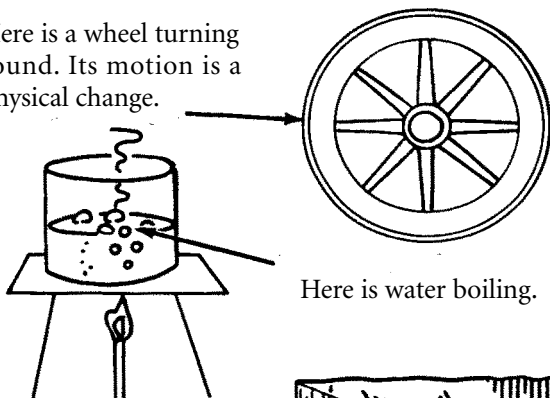

Here is water boiling.

And here is water turning into ice.

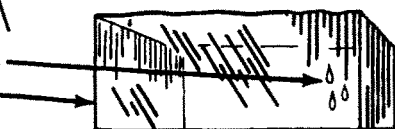

Here are clouds forming and rain falling.

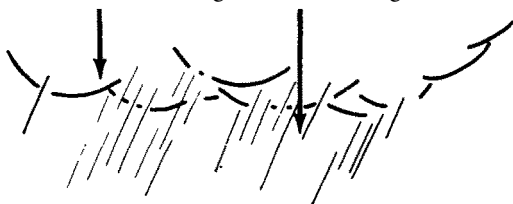

These are physical changes.

physical: in the narrow sense used here, within the field of the science of physics. In a wide sense, material having to do with bodies not minds.

Much later, other sorts of changes, more complex than these, began to take place.

Here is a lighted candle. As it burns the heat melts the candle and the liquid goes up into the flame where it is turned into gas.



So far all is physical.

But in the flame chemical changes take place.

Carbon from the candle and oxygen from the air come together to make carbon dioxide. At the same time water is given off, as you may see if you hold a glass cover over the flame. The cover quickly becomes clouded with little drops of water. This water was not in the wax and the candle flame gives it off however dry the air is. The water and carbon dioxide come into being through the chemical exchanges, between the lighted candle and the air, which make the flame.



At the same time there are physical changes taking place. The top of the candle is melting and the liquid fuel is moving up into the flame and being turned into gas, air is coming into the flame, carbon dioxide and water are moving up from it and heat and light are being given out.

chemical changes: changes that take place in the structure of different sorts of material, turning them into other materials.

When you step on a scale, the scale goes down and the springs inside it are pulled out, and the pointer moves to a mark. These changes are physical.

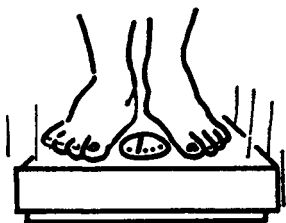

When you look at the pointer to see what your weight is, rays of light come from it to your eye and go through the lens in your eye to a point on the retina.

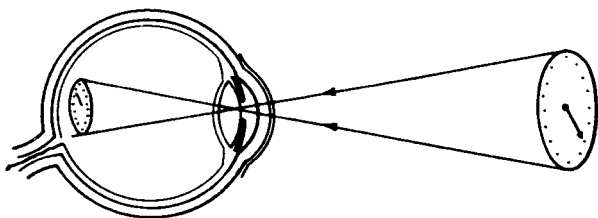
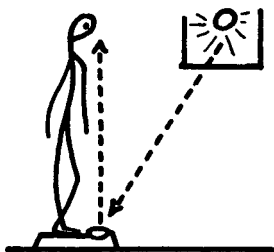

lens: lenses in cameras are made of glass. The lens in an eye is built of clear living cells.

retina: coat of cells at the back of the eyeball.

In a camera, rays of light from whatever you are photographing make an upside down picture on the film.

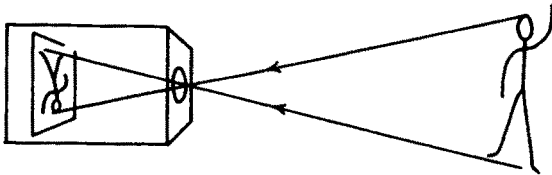

So it is inside your eye. The pictures made on the retina are upside down.

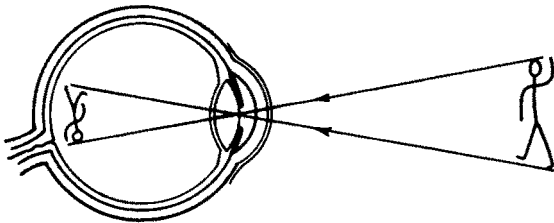

Everything going on so far has been physical. But in your retina more complex sorts of changes now take place. Some of these are chemical. Complex materials in the retina go through chemical changes not very unlike those that make photographs on films, and these changes cause other much more complex sorts of changes in the living cells of the retina.

film: here is a roll of film ready to be put into a camera.

cause: be the cause of.

will cause

cause(s)

caused

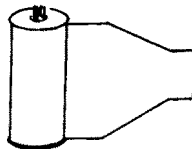

These nerves, which make us able to see, are an outgrowth from the brain to the retina. From the eye impulses travel to the brain through the living cells of the nerves. There are as many as a million separate telephone lines in these nerves alone.

A train of changes goes up these nerves to the back part of the brain. The cells there let us see the things that our eyes are looking at. No one, at present, has any idea of how they do this.



The distance from the eye to the back of the brain is not great, but some distances from some parts of the body to the brain are long. The rate at which impulses travel through the nerves is about the same for all of them.

impulse: wave of change which goes through a nerve.

nerve: chain of cells through which impulses travel from one part of the body to another; the impulses themselves. (See page 181, line 3. It is our nerves that get tired today.)

The distance from one's toe to one's brain and back may be as much as twelve feet. When you are feeling with your toe for a step to put your weight on, the impulses have to go up your nerves from your toe to your brain and back down again to the muscles which move your foot.

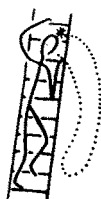

When you are walking, almost all the muscles in your body are at work keeping you from falling down. Your muscles and nerves work together to keep you on your feet.

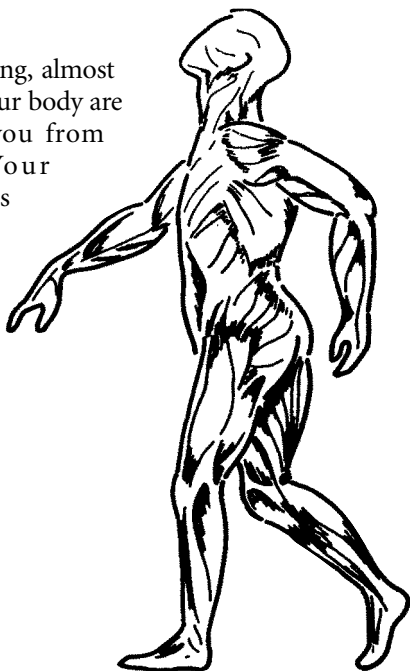

These changes in the nerve and muscle cells are dependent on what is going on in other cells in the body in many different ways.

Life on earth began, it is thought, about two billion years ago. No one knows for certain whether there are living things on other planets—on the red planet, Mars, for example, or on any of the ten million, million planets like the earth which are now thought to be traveling round other stars which are like our sun. It seems possible—even probable—that there are living beings (not unlike us maybe) on many of them.

Changes of color on Mars are seen at different times of the Martian year. These changes may be caused by the growth of plants.



The newest and highest development of living things on earth is human life. About a million years ago, early men and women were beginning something new in the long story of the earth.

Let us change our time scale and make this line:

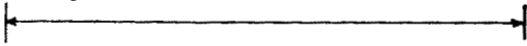

represent five hundred thousand years, the time since human life began.

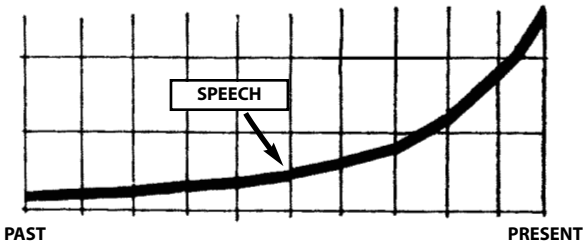

Then this curve may represent the next great steps forward into more complex ways of living.

No one knows for certain when speech began. Probably speech developed slowly and in different ways and at different times with different sorts of people. But certainly it was through being able to speak to one another that we became human. With the growth of language a great development of the parts of the brain which are used in talking took place. Speech gave us greater and greater control over the world, over others and over ourselves. Without language, we would not have become what we mean by the word *human*.

speech: talking, word language of the voice.

will speak

speak(s)

spoke, spoken

Let us change our time scale again and make our line represent 10,000 years.

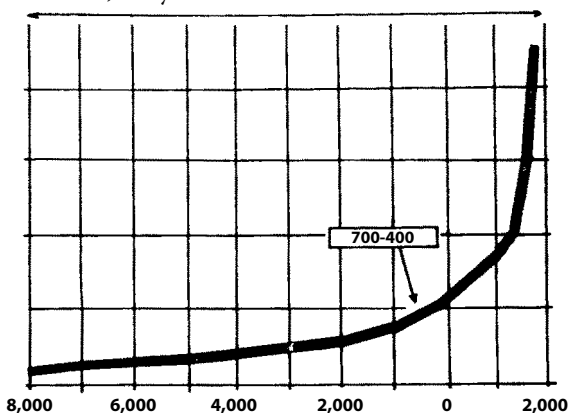

The next great upward turn of our curve came some twenty-five hundred years ago. In many different parts of the earth, people were discovering then their first full and clear ideas of themselves and of their world.

In Greece, the great poem the *Iliad*, and Socrates and Plato.



In Palestine, Amos, Hosea and Isaiah.

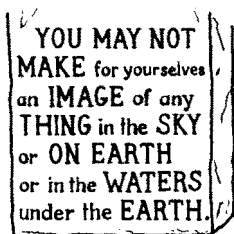

"You may not make for yourselves an image of anything in the sky or on earth or in the waters under the earth."

(Deuteronomy, 5:8.)

image: picture or sculpture representing something.



In India, Gautama Buddha and the Bhagavad-Gita.



In China, Confucius and Mencius.

At first through the spoken word and then in writing, we began to make for ourselves pictures of ourselves and of what we should become. More than some know, we have been living by these pictures ever since.

If you have read this book up to this point, you can easily read for yourself *The Wrath of Achilles* (Homer's *Iliad*) in simple English, *The Republic of Plato* in simple English (both W. W. Norton, New York) and the Books of Amos, Hosea and Isaiah in *The Bible in Basic English* (E. P. Dutton, New York).

Here are some of the greatest sayings of all time which, in one language or another, go on living in people's minds. For many centuries school children in China began to learn to read with this sentence:



“Human nature is good.”
Mencius
(4th century B.C.)

From the *Chung Yung* (a later work of the school of Confucius):

“What makes us is named our nature. What directs our nature is named the Way. What makes the Way possible is education.”

our nature: what we most deeply and truly ARE.

directs: gives directions to.

will direct

direct(s)

directed

From the *Bṛihadāranyaka Upanishad* (6th century B.C.):

“Yājñavalkya said, ‘You cannot see the seer of seeing or hear the hearer of hearing or think the thinker of thought or know the knower. This is the Self. Your own Self lives in the hearts of all.’”

From the *Apology*
of Socrates:

“I do nothing, men of Athens, but go about telling you, young and old, not to care for your bodies or your property so much as for your souls.”

Socrates was speaking to the Athenians who were making up their minds to put him to death. Socrates (469–399 B.C.) was the first man to talk of the soul (*psyche*) in the sense in which we have used the word since then.



property: things we own: land, houses, money, furniture, clothing, etc.
soul: that in a person which is their true self.

At first, writing seems to have been chiefly a way of keeping records. The first great poems, the *Iliad*, for example, were in the minds and mouths of poet after poet before they were written down.

The teachings of Buddha and of Mencius, Confucius and the earlier Hebrews were given first by the spoken word and written down later by some who heard them. Socrates, though he used books, thought that teaching should be by word of mouth and by example. And Jesus taught only by what he said and did and was.



Later, the written word was to become the chief instrument through which we could try to understand ourselves and our world.

It is chiefly through reading, and through thought about what we read, that we come to see how our ideas depend upon one another—very much as we are dependent upon others, or as organs in our bodies are interdependent.

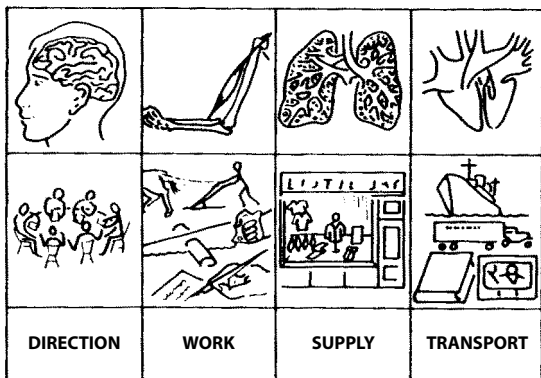

Through reading and reflection we can learn to know ourselves. Reflect for a while on these words of Shakespeare. Thinking, he says,

“... turns not to itself
Till it has traveled and is mirror’d there
Where it may see itself.”

Troilus and Cressida, Act III, Scene iii, lines 109-111.

Some very good students of Shakespeare think that he wrote *married*, not *mirror’d* in line 110.

organ: heart, lungs, stomach, brain, etc.

interdependent: dependent on one another.

reflection: if you look in a mirror (looking glass, *EP 2*, p. 107) you will see a reflection of yourself. The mirror reflects light from you back to your eye. The eye is the sense organ most clearly servant to the brain. When we understand, we say “We see.”

will reflect

reflect(s)

reflected

Every idea with which we reflect is what it is and can do what it can do only because our other organs of thought are what they are and do their own work.



The parts of this bridge do what they do only because the other parts of it are there and are doing their work.

And this is equally true of the words in a language. Every word is able to work as it does only because other words work with it.

In every step we take, what any of our muscles can do depends on what our other muscles are doing, and all this is possible only because our nerve cells are in control. And nerve cells can work together well only if the blood is serving them well.



But in fact, the organization of our bodies is far more complex than this short and simple account can say. In everything we do, every breath we take, every motion we make, from the directing of our eyes as we look to the wording of a sentence as we write, billions of cells of every sort in our bodies are working together serving one another.

It is the same with us and our world. Any great question coming up in any part of the world today has its effect on almost everyone anywhere. As with the body, damage in any part is damaging to all the rest. The more we reflect upon this the more we will understand why world organization is important. We are far more dependent upon one another than we know.

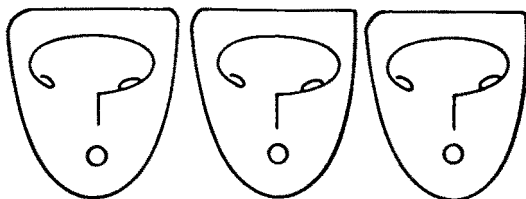

“What to do? What to do?” said Confucius. “In truth, I do not know what to do with a man who does not ask himself this!”

Wise people go on asking themselves what to do all their lives. It is two questions:

1. What should I want to be or to become? What is our end or purpose? We have seen (page 204) how far we have come. Where are we going?
2. How can I best work to this end?

organization: way of being organized (see page 115).

Everything, said Aristotle, has its own true work—or purpose—the work it can do best, the work which is right for it.



A good wheel turns well, a good knife cuts well, a good clock keeps time well. A good apple tree gives good fruit, a good cow gives good milk.



In the body, eye, hand, foot, each has its own work to do.

What can we do best? What is our own work as a person?

Is it to learn? To learn what?

Is it to learn what to do?

How does one learn?

Is it by the feed-back from the effects of what one does?

Is it by seeing from the outcome whether one is doing the right thing?

If you are trying to draw a circle, the curved line you have made (together with your knowledge of what a circle is) keeps telling you how to go on. You can learn to draw better by trying.

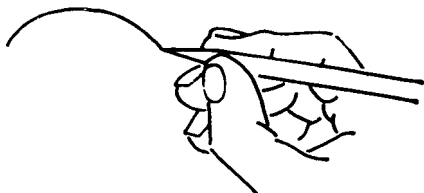

If you are making a speech, what you will go on to say depends upon what you have said up to that point and upon the people listening to you. A bad speaker is one of whom this is not true. A good speaker has learned by experience how to design a speech and how to change the design if necessary.

In speaking, as in everything we do, the way we begin depends upon what our purpose is, upon what we are trying to do. But we are not always, nor need we be, fully conscious of what that purpose is. Sometimes, in reflection, we see more purpose than we knew in what we did.

design: see what should be done and how to do it.

will design

design(s)

designed

How you start your circle depends on how large it is to be.



So there is feed-forward as well as feed-back. Feed-forward is as widely supported a fact as feed-back. Any number of examples can be found. There can be no feed-back without feed-forward. Knowledge of what you have done and are doing will not help you unless there is direction in what you are trying to do.

You may not fully know what this direction is; you may be trying to find out what it is.

As the development of the microscope (page 73) has increased our power to see, so the development of instruments of thought is increasing our power to design and direct and see what we are doing.

In every sentence you write, the feed-back from the letters of any word you are writing, together with your knowledge of the spelling of the word, tells you which letter to write next. But feed-back can do this only because you fed forward that word and no other as the word you would write. And in writing any sentence, feed-back from the words you have written can tell you what to write next only because you fed forward that sentence. And you fed forward that sentence only because of a more general feed-forward, the purpose of the paragraph in which the sentence is to take part. And the paragraph too depends upon the chapter and the chapter on the book.

“General”? What does this word mean? Each of these circles as they go out from YOU represents a more general idea than all that is within.



paragraph: a part of a longer piece of writing which develops an idea in it.
chapter: a part of a book made up of a number of paragraphs under a separate heading (or number).

Every breath we take is controlled by feed-forward and feed-back. If you want to be heard at the back of the room you take a deeper breath as you speak. And why do you want to be heard? What part does what you have to say take in your larger purposes, and in the larger purposes still in which you take part? Before life came up out of the sea, it seems probable that there was no free oxygen or carbon dioxide in what is now the air. The gases necessary for life on land were put into the air, scientists think, little by little by living things themselves. What over-all purpose is there of which all our purposes are parts?

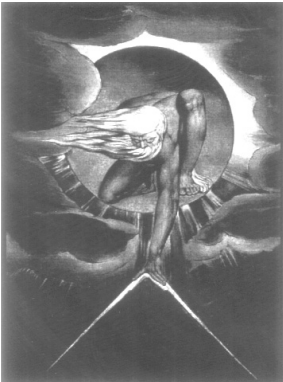

Here is a rough copy of one of the greatest works of William Blake (1757–1827). It represents Design at work beginning to give order to the world.

John Amos Comenius (1592–1670) was, so far as we know, the first man to use pictures in books written for beginning readers and for beginners in a second language. (It was Latin.) He was to have been the first head of Harvard College, where this book is being written, but could not come.

Comenius began his reader, *Orbis Pictus* (Nürnberg, 1657), with this picture.



The teacher is saying: “Come, Boy, learn to be wise.” And the boy asks: “What does this mean, *to be wise*?” The teacher answers: “To understand rightly, to do rightly and to speak out rightly all that is necessary.”

The teacher gives the boy an answer though he knows that no one can become wise all in a minute. All our lives through, we go on learning how to understand rightly, to do what is right, and to speak out at the right time. See the size of the question the boy is asking!

In this book we have not tried to give any answers, but only to bring together some of the more important ideas and facts needed if we are to ask ourselves what we should know and think and feel and desire and do. To have been wise is to have known, thought, felt, desired and done as was best. But there are many different ways of knowing, thinking, feeling, desiring and doing. Which are the best? That is the question. Our lives are our attempts to find an answer, and language is the most important of all our instruments for this purpose.

desire: have a desire for.

will desire

desire(s)

desired

INDEX

WORDS IN THIS BOOK
AND IN
ENGLISH THROUGH PICTURES
BOOK I AND II

The number after each word indicates the page of this text on which the word first occurs. This index includes words of *English Through Pictures Books I and II*.

(Only words taught in this book carry page numbers.)

A	among 125	attraction
a	amount	August
abacus 168	an	automatic 82
able	and	automobile
about	angle	awake 82
above 84	animal	away
account	another	B
across	answer	baby
act 119	any 4	back
add 169	apartment 20	bad (worse, worst)
addition	apple	bag
after	April	ball
afternoon 151	are (were)	bank
again	area 174	barometer 84
age 5	arm	basin
ago 9	art 144	basket
air	art gallery 145	be
airplane	artery 77	bean 127
alive 33	artist 145	beautiful
all	as	because
almost 3	ash 80	become 32
alone 147	ask 4	bed
alphabet 31	asleep 110	bedroom
always 66	astronomer 208	bee 48
am (was)	astronomy 208	beetle 48
America	at	before
	attempt	

- begin 58
bell
below 85
bent
between
bird
birth 3
bit
bitter
black
blade
blanket 137
blood 71
blow
blue
board
body
boiling
bone
book
bookshelves
bookstore
boot
born 4
both 98
bottle
bottom 171
box
boy
brain
branch
bread
breadbox
break 106
breakfast 26
breath
breathe 69
bridge 50
bright
bring 183
broken
brother
brush
bucket
build 30
building
burn 74
bus
business
but
butter
button
button-hole
buy 21
by
C
cake
camera 42
can 24
Canada
candle 86
cape 103
car 133
carbohydrate 130
carbon dioxide 81
card
care 136
carriage
carry 45
cart
carton 23
cat
cause
cave 161
CD 56
ceiling 192
cell 72
cent
centimeter 120
century 16
certain
chain 94
chair 18
change
chapter 230
cheap 192
check
cheese
chemical 211
chemist 124
chemistry 124
chest
chief
child 22
chin
chlorophyll 130
church
cigarette 74
circle 172
circulation 79
city 16
clean

-
- clear
climate 186
clock
cloth
clothing
cloud
coal 80
coat
cold
collar
color
comb
come (came)
common 52
company 191
compare 106
compass 170
complete 61
complex 116
computer 198
conscious 82
continent 102
control 85
cook 5
cool 91
copy 142
cord
corn 34
cotton
count 93
counter 164
country 3
cover
cow
crushing
- cry
cube 120
cup
cupboard 25
curve 14
cut
- D**
- daily 139
damage 191
dance 141
danger 190
dark
date 5
daughter
day
dead 24
dear
death 110
December
deep
degree 88
depend 119
dependent 118
design 181
desire
develop 73
development 73
die 24
different
digestion 126
dinner 26
direct 220
- direction
dirty
discover 34
discovery
disk 56
distance
divide 112
division 112
do (did, done)
doctor 79
dog
dollar
door
doorway
down
draw 142
drawer
dress
drink
drop
dry
- E**
- each 9
ear
early 23
earth
east
eastern 37
easy 65
eat 31
edge 121
education

effect
egg
eight
eighteen
eighty
either 129
electric 18
eleven
empty 180
end
energy 30
engine
enough
equal
even 98
evening 151
ever
every
everybody 39
everything
everywhere 15
example 29
exchange 97
experience 127
experiment 127
eye

F

face
fact 172
factory 18
fall
false

family
far
farm
farmer
farther
fast 49
fat
father
fear 185
feather 48
February
feed 28
feed-back 205
feed-forward 229
feel 64
few 25
field
fifteen
fifty
film 213
find 100
finger
fire
first
fish 35
five
fix
flag 52
flame
flat 99
floor
flour 37
flower
fly 26

fold 121
food
foot (feet)
for
foreign 44
fork
form 135
formula 124
forty
forward 94
four
fourteen
fourth
frame
free 67
fresh 27
Friday
friend
from
front
fruit
fuel 74
full
furniture 18
future 51

G

gallon 23
garden
gas 25
general 230
geometry 170
get (got)

-
- girl
give (gave, given)
glass
glove
go (went)
goat
good (better, best)
govern 200
government
grain 28
graph 10
grass
gray
great
green
group 57
grow 34
grownup 65
growth 122
gun
- H**
- hair
hairbrush
hairpin
half
hammer
hand
hanging
happy
harbor
hard
hat
- have (had, has)
he
head
health 149
healthy 15
hear 46
heart 76
heat
heavy 49
help 57
her
here
herself
high
him
himself
his
history 47
hold 83
hole
hollow 48
home 20
hook
hope 185
horse
hospital 89
hot 90
hotel 189
hour
house
housekeeper
how
however 94
human 108
- hundred
hungry 111
husband 22
- I**
- I
ice
icebox
idea
if
ill 88
image 218
important
impulse 214
in
inch
increase 9
independent 147
industry 131
insect 45
instrument
insurance 191
interdependent 223
interest 140
into
invent 167
invention 58
iron 19
is (was)
island
it
its
itself

- J**
January
jelly 115
journey
judge 201
July
June
just 183
- K**
keep (kept)
kettle
key
knee
knife (knives)
know 30
knowledge
- L**
lamb 162
land
language 2
large 34
last
late 58
laugh
law 106
leaf (leaves)
learn 44
left
leg
lemon 32
length 173
lens 212
let
letter
library 146
life 110
light
light-year
like
limit 200
line
lip
liquid
fist 197
listen 56
liter (litre) 23
little (less, least)
live 1
lock
long
look
loose 32
loud
love
low
lunch 26
lung 70
- M**
machine 18
make (made)
man (men)
many 5 (more, most)
map
March
mark
married 22
match 74
material 19
may
May
maybe 132
me
meal 26
mean 52
measure
meat
meet 150
melt 192
metal 19
metre (meter)
Mexico
microscope 46
microscopic 132
middle
mile
milk
mill 184
millimeter 120
million
mind
mine
minute
mirror 223
Monday
money

-
- monkey
month
moon
morning
mother
motion
mountain
mouse 128
mouth
move 71
Mr.
Mrs.
Ms.
much (more, most)
multiply 169
muscle 77
museum 145
music
must 27
my
- N**
- nail
name
narrow
nation 147
natural 106
nature 220
near
necessary 69
neck
need 13
needle
neither 129
- nerve 214
nervous 225
never 158
new
newspaper
next 16
night
nine
nineteen
ninety
nitrogen 125
no
nobody
noise
noon 151
nor 129
north
nose
not
note
November
now
nucleus 115
number
nurse 89
- O**
- ocean 132
occupation 5
October
of
off
office
- often 181
oil 132
old
on
once 94
one
only
open
opposite
or
orange
order 165
organ 223
organism 114
organization 226
organize 115
other
our
ourselves
out
over
own 73
oxygen 75
- P**
- page
pain
paint
paintbrush
painter
paper
paragraph 230
parent 54

- part
past 51
patient 89
pay 96
pen
pencil
pendulum 95
people 6
per cent 114
person
philosopher 140
photograph 42
photosynthesis 130
physical 210
picture
piece 96
pig
pin
pint 23
pipe
place
plane
planet 104
plant
plate
play
please
pleasure
plow
pocket
poem 207
poet 222
poetry 146
point
poison 24
police 139
population 8
possible 92
post
postcard
pot
potato
pound
powder
power 18
present 51
pressure 84
price
print 97
prison 105
private 40
probable 206
proof 95
property 221
protein 125
prove 95
public 37
pull
pulse 93
pump 76
purpose 187
push
put
- Q**
quart 22
quarter
- question
quick
- R**
radio 43
rail
railroad
rain
rate
ray
read 51
ready
record 51
rectangle 177
red
reflect 223
reflection 223
relation 4
religion 151
represent 10
responsible 191
rest
restaurant 26
retina 212
rice 34
right
ring 189
river
road
roll
roof
room
root

rough	serve 194	skin
round	service 139	skirt
run 87	seven	sky
S	shake	sleep
's	shape 175	slow
safe 189	sharp 58	small
sail 7	she	smell
salt	sheep	smile
same	sheet 137	smoke
sand	shelf	smooth
say (said)	ship	snake 110
scale	shirt	snow
school	shiver 90	so 50
science	shoe	soap
scientific 131	shoemaker	sock
scientist 33	shop 196	soft
scissors	short	soil 134
sculpture 143	should 203	solid
sea	shoulder 107	some
seaside	show 112	something
seat	shut	sometimes
second	sick 88	son
see (saw, seen)	side	song
seed	silk	sort
seem	silkworm	soul 221
self 221	simple 116	sound
sell 21	since 131	soup
send (sent)	sing 47	south
sense	sister	space 46
sentence 56	sit 43	spade
separate 112	six	speak 217
servant 194	sixteen	speech 217
	sixty	spell 61
	size	sponge 71

- spoon
spot 104
spring
square
stamp
stand 92
star
start 7
state
statement
station
steam
steel 19
stem
step
stick
still 167
stocking
stomach 126
stone 58
stop
store
storekeeper
story
straight
strange
stream 75
street
strong
structure 108
student 152
studio 190
subtract 169
such 109
- sugar
sulphur 125
summer
sun
Sunday
supper 26
supply 20
support
surface 113
surprise 109
sweet
swim
system 61
- T**
- table
tail
take (took, taken)
talk
tall
tally 163
tape 56
taste
taxi
teach 29
teacher
telephone 43
telescope 46
television 43
tell 164
temperature 88
ten
than
- thank 153
that
the
theater 146
their
them
themselves 26
then
there
thermometer 88
thermostat 186
these
they
thick
thin
thing
think 54
thirsty 91
thirteen
thirty
this
those
though 100
thought
thousand
thread
three
through
thumb
Thursday
ticket
till 36
time
tired 150

to
tobacco 74
today
toe
together
tomato 32
tomorrow
tongue
too 30
tooth (teeth)
toothbrush
toothpaste
top
touch
town
trade 167
train
transport
travel 155
tray
tree
triangle 41
trousers
truck 28
true
trunk 122
truth 166
try 65
Tuesday
turn
twelve
twenty
twice 14
twist

two
U
umbrella
uncle 4
under
understand 154
unhappy
unit 174
unite 80
universe 105
unless 229
until 36
up
upkeep 139
us
use
V
valve 77
vegetable 24
vein 77
very
vitamin 30
voice 47
volume 175
W
wait 131
waiter 194
waitress 194
walk

wall
want 66
warm
wash
washcloth
waste 72
watch
water
wave
wax 211
way
we
weak 32
weather
Wednesday
week
weight
well
west
wet
what
wheat 34
wheel
when
whenever
where
whether 47
which
while 111
whistle
white
who
why
wide

wife 22
will
wind
window
wing 48
winter
wire 43
wise 83
with
within 127
without 32
woman (women)
wood

wool
word
work
worker 18
world 14
worm
wrist 93
write 51
writer
wrong

Y

yard

year
yellow
yes
yesterday
you
young
your
yours

Z

zero 169